

1
2
3
4
5
6
7
8
9
10
11
12
13
14
15
16
17
18
19
20
21
22
23
24
25
26
27
28
29
30
31
32
33
34
35
36
37
38
39
40
41
42
43
44
45
46
47
48
49
50
51
52
53
54
55
56
57
60
61
62
63
64
65

Leaf Disease Identification through Transfer Learning: Unveiling the Potential of a Deep Neural Network Model

Naresh Kumar Trivedi

Chitkara University Institute of Engineering and Technology, Chitkara University, Punjab, INDIA
nareshk.trivedi@chitkara.edu.in

Deden Witarsyah

Information System Department, School of Industrial and System Engineering, Telkom University,
Bandung, INDONESIA
dedenw@telkomuniversity.ac.id

Raj Gaurang Tiwari

Chitkara University Institute of Engineering and Technology, Chitkara University, Punjab, INDIA
rajgaurang@chitkara.edu.in

Vinay Gautam

Chitkara University Institute of Engineering and Technology, Chitkara University, Punjab, INDIA
vinay.gautam@chitkara.edu.in

Alok Misra

School of Computer Application, Lovely Professional University, Phagwara, Punjab, INDIA
alokalokmm@gmail.com

ABSTRACT

Grape is one of the world's most crucial and widely consumed crops. The yield of grapes varies depending on the method of fertilisation. Hence, some other factors also impact crop production and quality. One of the major elements affecting crop quality output is leaf disease. Therefore, it is necessary to diagnose and classify diseases earlier. Diseases impact grape production in many ways. It could reduce the disease's impact on grapevines if the disease were identified earlier, which would result in higher crop output. There has been a lot of experimentation with new approaches to diagnosing and classifying diseases. This endeavour aims to assist farmers in accurately analysing and informing themselves about illnesses in their early stages. The Convolutional Neural Network (CNN) is an effective method for identifying and categorising grape diseases. A dataset of 3297 images of grape leaves affected by four distinct diseases and a healthy leaf was used to conduct the entire experiment using python and orange software. Here's a rundown of the whole procedure: Before the actual segmentation of the images begins, input images are first pre-processed. The images are then subjected to the second processing round using several CNN hyper-parameters. Finally, CNN analyses images for details such as colour, texture, and edges, among other things. According to the results, the proposed model's predictions are 99.3% correct.

Keywords: Deep Neural Network; Transfer Learning Leaf Diseases; Classification; VGG; SqueezeNet

1. INTRODUCTION

Wine, brandy, non-fermented beverages, and fresh or dried raisins are all made from grapes, which are among the most widely cultivated fruits in the world. Approximately 81.22% of India's total grape production comes from Maharashtra, which also happens to be a significant exporter of fresh grapes [1][2]. The grapes are processed into juice and dried to produce raisins [3]. Also, wine and brandy are prominent spirits made from fermented grapes [4]. However, the grape industry has suffered significant losses due to diseases in grape leaves. Black rot, a disease transmitted by pathogens, is one of many disorders that damage grapes. Hence, leaf disease is a primarily focused pest control and disease detection area in orchards [5]. Unfortunately, a human was only responsible for detecting leaf disease, which led to a decade of time, money, and productivity loss.

As a result, new diseases emerged in unknown places where the native ability to combat them was inadequate. Therefore, an automated disease detection system is necessary for earlier disease detection. Furthermore, earlier disease detection will save money and improve product quality [6-9]. Plant diseases, including black rot, Esca, and Leaf Blight, and insect pests like beetles, thrips, and wasps, can cause significant damage to grapevines [10]. Problems can be eliminated with the use of sprays [12]. Early detection and treatment of infections are essential to produce a healthy crop of grapes. Deep learning techniques and methods are the best ways to detect infectious objects.

When two tasks are similar enough, machine learning experts may use what they have learned in one to tackle the other. This technique is called transfer learning. Transfer learning can improve a model's performance in detecting objects. The application of deep learning aids in developing solutions to various problems. Responses to the problem based on technology have been implemented. However, the same issue is addressed in this study with a more effective method. The following points are considered in the proposed techniques.

Shift in light and spectrum reflectance are two concerns that the suggested technique aims to accomplish in this case, focusing on the lesion.

It must address insufficient image contrast in the supplied image (c) image size and form range problems. Image contrast, grayscale conversion, and image scaling are all examples of pre-processing operations [15-17].

The next stage is to break an image down into its constituent parts. Using these items, researchers can identify contaminated areas in the image. The segmentation method has some drawbacks:

Color segmentation fails when lighting conditions change from those of the original images. Seed selection plays a role in regional segmentation. All the many types of texture take too long to manage.

The use of CNNs in disease detection on grape leaves is discussed in this research. This strategy addresses two significant issues: CNN models need training data for starters. While each disease emerges at a different time of year, there is limited time to collect images. A sample's classification begins with deciding which category it falls within. This process also polls this method's input variables. A specific input type is recognized a few times a year. The most challenging task is to increase classification accuracy. This data is then used to develop and verify new datasets different from the training set. Therefore, creating the best CNN structure to detect grape leaf diseases is problematic. Grape leaf disease detection using a better CNN algorithm is the paper's essential contribution and innovation, and it is summarized as such below:

A grape leaves disease data set must be constructed to generalize the model. The model's sturdiness is enhanced by acquiring images of damaged grape leaves with complex and consistent backgrounds. In addition, data augmentation techniques are used to build additional training images from the initial diseased grape leaf shots, which reduces the model's tendency to overfit. Using digital image processing technologies, it is also possible to mimic images of grape leaf diseases in various conditions. This method improves the generalization performance significantly [11]. Using a more advanced CNN model, diseases affecting grape leaves may be identified.

Furthermore, the deep convolution neural network model is proposed to investigate the features of sick grape leaf images. One benefit of deep separable convolution is that it helps keep the model's first two convolutional layers from being overfit by reducing the number of parameters. Afterwards, the Inception structure improves the extraction performance for multiscale illness areas. These four cascade Inception structures are then given a dense connection method to alleviate the disappearing gradient problem, promote feature propagation, and reuse.

The paper's main contribution uses the features of different transfer learning techniques for a better disease classification technique. Valuable performance metrics include “AUC”, “Accuracy”, “F1 Score”, “Precision”, “Recall” and “ROC Curve”. In the proposed algorithm, we have used semantic segmentation of Images to enhance disease prediction. The suggested algorithm is contrasted with both contemporary and conventional methods. The proposed algorithm shows no drawbacks in the implemented scenarios. Experiments have shown that the proposed model has a greater accuracy rate (99.3%) than any classic model. In addition, we used a data set of 3297 sick grape leaves to boost accuracy by 14.42%, demonstrating better robustness and identification performance.

The paper is organised as follows: Section 2 looks at recent research. Section 3 then goes on the supplies and process that were utilised. The analysis and discussion of the findings are explained in section 4. Section 5 serves as the last section.

2. RELATED WORK

Artificial intelligence has made significant strides in recent years because of developments in Deep Learning. This is very helpful for image-based classification and recognition. Applications include the detection and classification of plant leaf disease and object recognition. The advantages and power of deep learning techniques are foreshadowed in earlier research. For example, in recent years, the researcher used many deep-learning algorithms to recognize plant leaves. As a result, deep learning techniques in image-based problems and agricultural applications are becoming increasingly common [12], as given below:

Principal Component Analysis (PCA) and back-propagation networks are used to develop a method for detecting and classifying diseases of grape leaves. The leaf disease samples included in the study are grape downy mildew and grape powdery mildew, respectively. It can recognize diseases with 94.2% accuracy using this method. Classification of grape leaf diseases has never been easier than it is, thanks to the technique used by the author in the thresholding technique. First, the image is pre-processed, and then the K-mean algorithm is used to segment the diseased area. By utilizing the hue features, this strategy produced better results in terms of accuracy [13][14].

Crops type and diseases can be identified using two deep-learning models [15]. Various training instruments, datasets, and training-testing sets are used to obtain a 99.35% accuracy rate. A mobile application has been created to assist farmers in identifying wheat leaf disease. The system was designed using a variety of deep learning algorithms, which resulted in accuracy rates of 97.95% and 95.12%, respectively. Many different CNN models are employed in [16] to diagnose weed disease accurately; however, the highest score is reached using VGG Net. The authors use an open library of 87,848 images of plant leaves to identify leaf disease using five alternative CNN architectures [17]. Using CNN's model, we obtained a 99.53% success rate. To identify grape leaf diseases, offer an approach. When applied to the ImageNet database, this SIFT encoding and pre-trained deep learning model achieves a 91% accuracy rate in feature extraction [18].

A novel neural network model is proposed in [19] based on VGG Net and inception to detect apple leaf disease and achieve 78.8 % accuracy. The authors used deep convolution neural networks to create a Refinement Filter Bank architecture to diagnose illnesses and pests of grape plants to avoid false positives and class imbalance. Primary diagnosis, secondary diagnosis, and integration made up the system's map, 13% higher than Faster R-CNN could provide. Plant leaf disease can be diagnosed more quickly and accurately using an innovative deep-learning approach with CNNs. According to this research, plant disease detection has been dramatically improved using CNNs. Furthermore, grape leaf diseases can be detected in real-time, although there are no adequate CNN models for this purpose. Therefore, this paper proposes a real-time grape leaf disease detector based on Faster R-CNN [20].

Various authors developed methods for detecting diseases on the leaves of orchid plants. Digital cameras capture images of orchid plant leaflets. The programmer employs a variety of tactics, including boundary segmentation, morphological processing, and a filtering strategy, to classify images into two disease categories: black leaf spot and solar burn [1]. Authors are primarily concerned with detecting disease in cotton and estimating its stage. The leaf can find most diseases and their symptoms [2]. The authors provide an overview of the characterization and detection of diseases of cotton leaves. It's tough to pinpoint the exact type of plant leaf disease afflicting a leaf. Accurately identifying cotton leaf diseases can benefit from image processing and artificial intelligence (AI). This report was based on information from a computerized camera. Pre-handling procedures for eradicating the foundation use the foundation expulsion technique on the image [3].

A “Learning Vector Quantization (LVQ)” algorithm and a CNN computation technique were used to identify the order of grape leaf infection. It can find about 500 images of tobacco leaves with four distinct signals in the data collection. They used CNN to extract and classify characteristics automatically. The Authors claim the opposite. Image explanation and information increase developments are initially used to produce the apple leaf infection dataset (ALDD), including detailed images and images of research facilities collected in actual field circumstances. Also, the Rainbow connection and Google Net Inception's structure using CNNs seems powerful for finding apple leaf disease. A dataset of 26,377 images of damaged apple leaves may be used to identify these five most common ailments, according to the INAR-SSD model proposed in this paper [21]. Extensively applied machine learning techniques in the early phases of classifying plant diseases. For example, the Authors developed an SVM classifier with an identification rate of 90% for grape downy mildew disease and a recognition rate of 93.33% for grape powdery mildew disease K-means clustering segmentation of the illness images. Many plant diseases are detected via image analysis because of advances in image processing technology [22].

They employed a neural network to identify whether a potato leaf was healthy or sick. BPNN could accurately identify and classify 92% of the disease areas it saw, according to its findings. By recognizing pathological signs with extremely high visual variance, significant intraclass dissimilarity, and low interclass similarity that botanists can only recognize, deep CNNs have significantly advanced plant disease

classification [23] [24]. On a dataset of 44 species, the CNN leaf image recognition accuracy was 99.7%. A limited number of large datasets were accessible. Using Google, the authors discovered cherry leaf powdery mildew disease 99.6% of the time. Transfer learning could help a deep learning algorithm recognize plant illnesses [25-26]. To identify fourteen distinct crop species and twenty-six distinct disease types, the authors used ImageNet-trained deep-learning models. Gathered 54,306 images of healthy and wounded plant leaves to verify the models' accuracy. In a hold-out test, they got 99.35% of the answers right [15].

CNN frameworks are widely used to classify agricultural illnesses. Many of these experiments have yet to improve classification accuracy, though. There will be no room for error if only one model is used. Therefore, teams generally combine multiple models to win a significant machine learning competition rather than relying solely on a single model as the Inception-ResNet-v2 [27] constructed by merging two huge deep CNNs, as its name implies. Integration is the most exact and practical solution for significantly different models [13]. As a result of our investigation, we've developed the United Model. With GoogLeNet and ResNet, the United Model combines two of the most prominent deep learning architectures. As a result, use transfer learning for better accuracy and reduced training time.

Deep learning has produced significant advances in computer vision since the advent of artificial intelligence. This method is one of the most common ways to diagnose and classify plant diseases. For example, grape disease can be identified using principal component analysis and a backpropagation network, according to [13]. The prediction accuracy was as high as 94.29% for downy mildew and powdery mildew grape diseases in the dataset. It was possible to distinguish two different grape diseases using the method described by [28]. The technique acquired good training accuracy using anisotropic diffusion and K-means clustering with characteristic hue thresholding. The authors used two deep-learning models to detect 14 crop species and 26 illnesses (AlexNet and GoogLeNet). The study showed that 99.35% of the training-testing sets were accurate after looking at two other training processes and three distinct dataset types [15]. To help farmers diagnose disease, the Authors created a smartphone application. After applying two other frameworks for the task, the mean recognition accuracy on WDD 2017 was 97% and 95%, respectively. The prior accuracy of 93.27% and 73.000% of the conventional CNN framework has been improved by this model. Weed detection in Bermudagrass lawns using deep CNN models has been previously reported. This study indicated that the VGG Net model outperformed the Detect Net model when detecting three of the most common turfgrass diseases. Considering these findings, a DCNN-based weed management system was presented. The authors reached the best results by applying five fundamental CNN architectures to 87,848 images spanning 25 plant species from 58 different classes, with an accuracy of 99.53% (2018a). Real-time disease detection during plant growth is more important than a deep CNN classification for preventing diseases from spreading [17].

Deep learning algorithms could be used to detect plant leaf disease reliably, which an increasing number of researchers are examining. The authors used signs of grape leaf Esca in the summer to identify and detect the disease. An image classification accuracy of 91% was achieved on ImageNet using the MobileNet

network, trained on the ImageNet dataset. It uses Classification and detection networks to reach the best Esca AP score (RetinaNet) [18]. The authors created the INAR-SSD network architecture using VGG Net and Inception building to identify apple leaf disease and achieved a 78.8% mAP success rate. It used Refinement filter banks to cope with false positives, class imbalance in disease and pest detection in grape plants, and a deep convolution neural network. With Faster R-CNN—which includes a main diagnostic unit, a secondary diagnostic unit, and an integration unit—the mAP is 13% more than the best result. A new deep learning approach based on CNNs has been developed to identify plant leaf disease accurately. Many studies have found that CNNs have helped detect and identify plant diseases [29]. Various methodologies and models are offered; however, more people produce adequate results. Therefore, a Faster R-CNN-based detector for grape leaf illnesses has been proposed as a real-time outcome of this study.

Various techniques and methods are proposed in the state of the art [30-31], but this paper is concerned with a high-performance deep learning model to detect grapes leaf disease. PlantVillage was the source of inspiration for the author's graphics. The performance of these neural network topologies was evaluated using a range of measures, including F1-score, recall and precision, and the model's inference time. This paper discusses various evaluation measures and unique deep neural network models.

3. MATERIAL AND METHODS

This section provides results using modern methodologies, models, and datasets.

3.1 Dataset

In the data set, diseases are separated into their groups. Fig. 1 shows sample images from dataset discovering several pathogens on grape leaves. The complete dataset is split 80:20 between training, testing, and validation data.

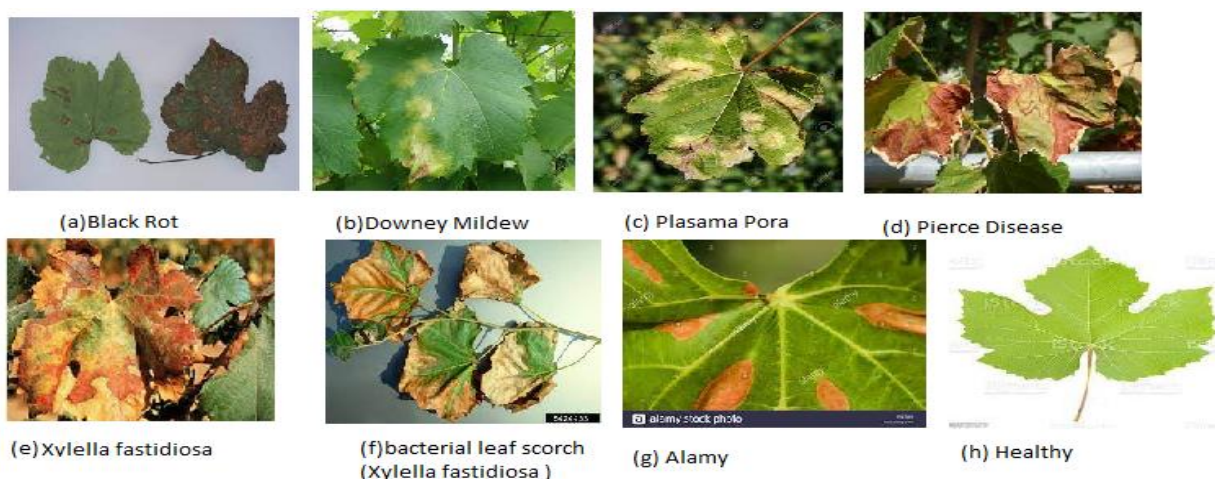

Figure 1. Sample of diseased or pathogenic leaves.

3.1.1 Dataset Description

The dataset consists of 3297 images split into four groups representing different diseases and their symptoms. Table I provides a comprehensive explanation of the dataset.

Table I. Dataset Description

Grapes Leaf Disease type	Count of images
“Grape__Black_rot”	843
“Grape__Esca_(Black_Measles)”	852
“Grape__Leaf_blight_(Isariopsis_Leaf_Spot)”	762
“Grape__healthy”	840
Total Images	3297

3.2 Image Processing and Argumentation

Using image preprocessing, argumentation, and semantic segmentation, a image was partitioned into many tiles and then used in the subsequent stage of the proposed method: the extraction of disease segments. After segmentation, images are used to retrain already trained models, like SqueezeNet, VGG16, etc. The many convolution layers in each pre-trained neural network are followed by several ReLu layers. The same output is subsequently fed into the deep neural network's upgraded, fully connected layer to initiate treatment. The proposed building's layout is shown in Fig. 3.

The images were preprocessed to increase the quality of the dataset used to train a deep learning network. As a first step, we've standardized image size by scaling each image to 256 pixels on each side using the Python Imaging Library and a Python script. The next step classifies the paddy images into groups and then specifies the paddy images for each illness.

Utilizing semantic segmentation enhanced the detection accuracy in this instance. The first algorithm describes segmentation as splitting the entire image into a predetermined number of tiles. The segmented tiles' assistance effectively extracted the leaf image's necessary portion. In both instances, feature extraction was performed using the same model training and evaluation data set. This technique was also intended to focus on the desired location inside a image, thereby reducing the unhealthy portion of the image and increasing the detection rate. The images were then fed into a neural network that had already been trained, as will be explained later.

The following is an algorithm for the detection of disease that has been proposed:

Algorithm 1: Semantic Masking

Input: Grapes Images Dataset

Output: Masking Grapes Image.

1. Generate the masked image ($Mask_V$) from Input Image (In_p)

2. With In_p and $Mask_v$ to get $Mask_f$;
3. Segment image $Mask_f$ into $Image_t$ (square tiles);
4. for ($Image_t$ in $Mask_f$) do
 - i. Categorize $Image_t$ into $Mask_f$ Grape diseases.
 - ii. if $Image_t$ is a disease then Identify Disease

End
5. for End

With the help of previously unexplored datasets, the validity of a machine learning model can be tested by cross-validation (also known as k fold). After a small sample of data was analyzed, the model's performance was evaluated on all available data. Because of the new information, they could make predictions about data that had not been included in the training procedure [17]. In our study used four pre-trained Convolutional Neural Networks on the ImageNet dataset:

3.3 Training Phase

This process involved numerous iterations in rationalizing the model's internal weights. The information was used to train a model that could then classify leaf diseases.

To train a model, one can either start from scratch or use transfer learning. Pre-trained on a large set of images (such ImageNet's 1.2 million images in 1,000 classifications), a network was then used and tweaked for a new purpose. As described in [83-85], multiple transfer learning procedures are utilized to deal with such problems.

A deep learning technique known as transfer learning involves retraining a network on a different dataset. The transfer learning process, seen in Fig. 2, entails adding new layers to the top of a prior-trained network (InceptionNet , SqueezeNet, VGGNet,). Among these layers are convolutional, fully connected, and multi-class softmax classification layers (in our paper, there are four). Each model was tested using a range of dropout percentages, learning rates, and batch sizes. Sections to follow will go into greater depth on the instructional and structural approaches.

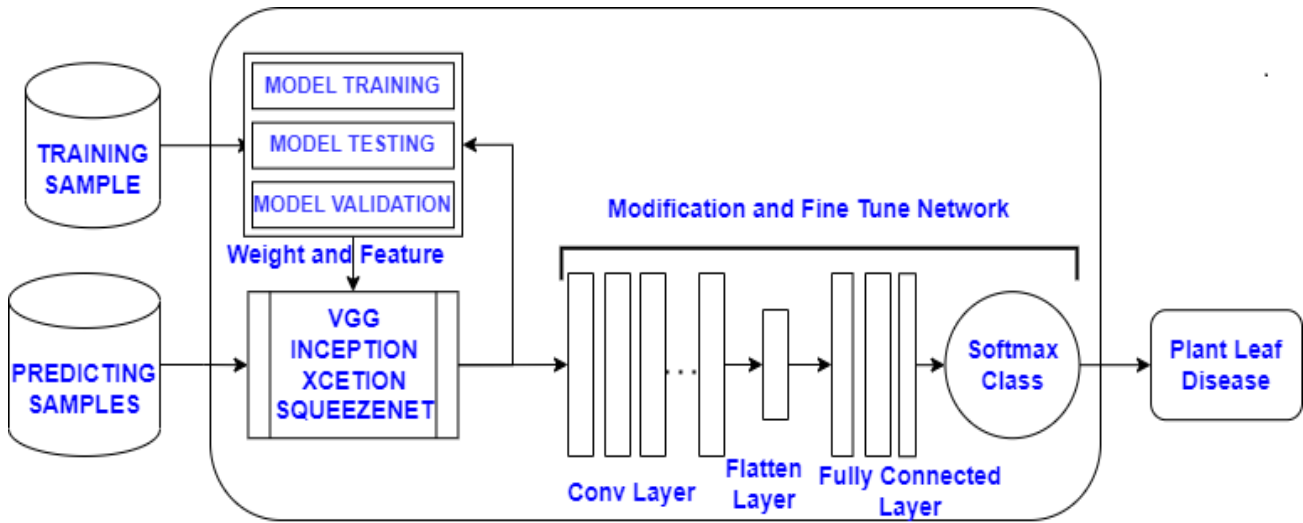

Figure 2. Transfer Learning with DNN

This cutting-edge method was created by adapting transfer learning models for agriculture, yielding useful insights. Using datasets of images of paddy-leaf, the author has improved upon various transfer-learning models. Transfer learning can be advantageous when training a model without access to previous weights. A new model was supposed to be trained with features derived from a huge dataset, as shown in Fig. 1, and then fine-tuned with specific data.

Essential ideas that must be considered while applying transfer learning methodologies are domains and tasks. Our objective is to classify leaf diseases; the relevant domain is image classification. As mentioned before, re-training would require several adjustments, extra data, and more time. Transfer learning models were used to zero in on certain domains and activities. Once these are known, training a Deep Neural Network (DNN) that is well-suited to the job is a breeze. This is the goal of transfer learning, and it is successfully achieved. The entire process flow is depicted in Fig. 4, while Table II outlines the enhanced architectural qualities utilized in the design. The following is a description of the deep neural networks utilized by TL:

3.3.1 Convolutional Layer

The convolutional layer is a vital part of any deep neural network, as it extracts both low-level and high-level features from the input image. Convolutional processing is carried out by this layer to extract meaningful data from the input. The network's early layers learn to categorize data concretely based on the input, while the later layers learn to classify the data abstractedly based on the output. In this study, we use a 3x3 convolution filter to extract features from images in the dataset that are 256 pixels on the longest side. Activation is employed with fifteen 33 kernel convolution filters (ReLU). As a result of this capability, more intricate traits can be learned from data. Therefore, the problem of vanishing gradients no longer exists. Convolution operation * between two real-valued functions (say, Z and Y) always produces the same outcome, as shown by the equation (Eq). (1). An abundance of input attributes is associated with each map feature. For instance, the input x of the ith convolution layer can be described by the following equations:

$$h_{i_c} = F(Z_i * Y) \quad (1)$$

This formula is composed of three parts: the activation function F , the convolution Y , and the convolution kernel Z . For a kernel with a single layer of convolutions, we have $Z = Z_{i_1} Z_{i_2}, \dots, Z_{i_k}$, where k is the number of convolutions.

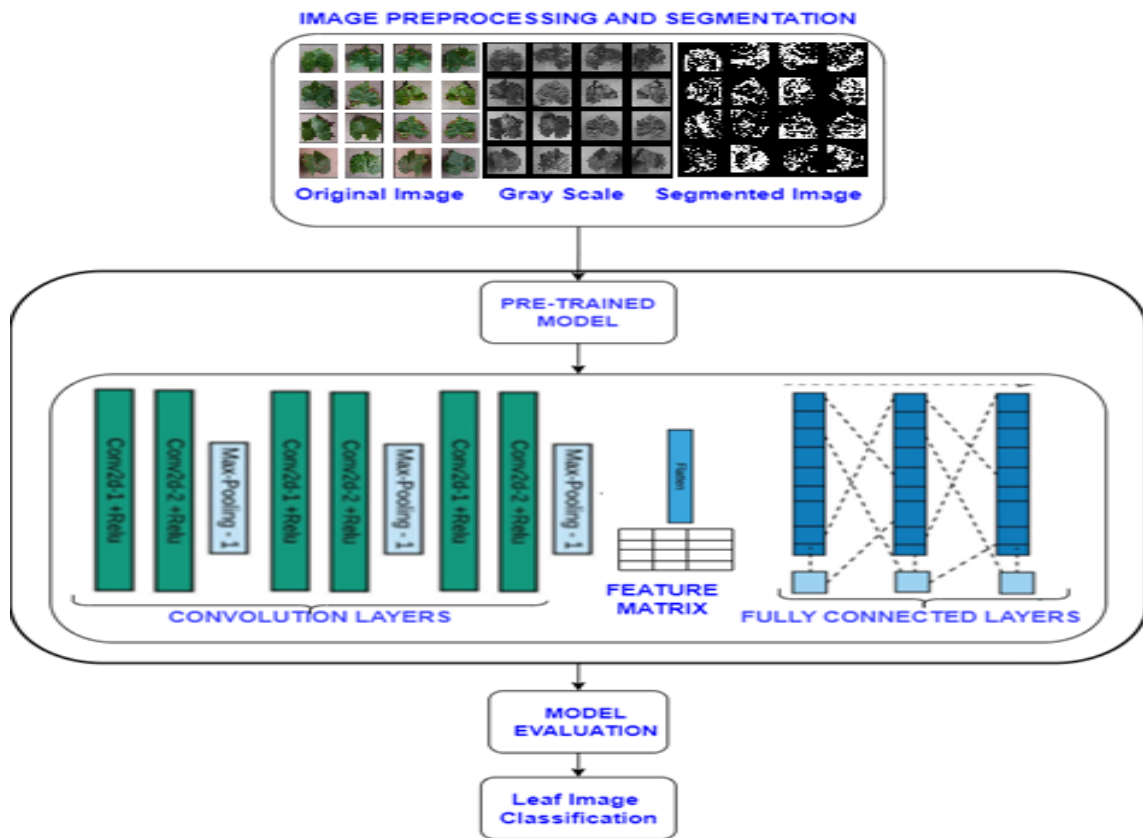

Figure 3. Proposed Model

This is the weight matrix:

$A * A * B$ is the kernel Z_{ik} .

Where:

A represents the window, while B represents the number of channels

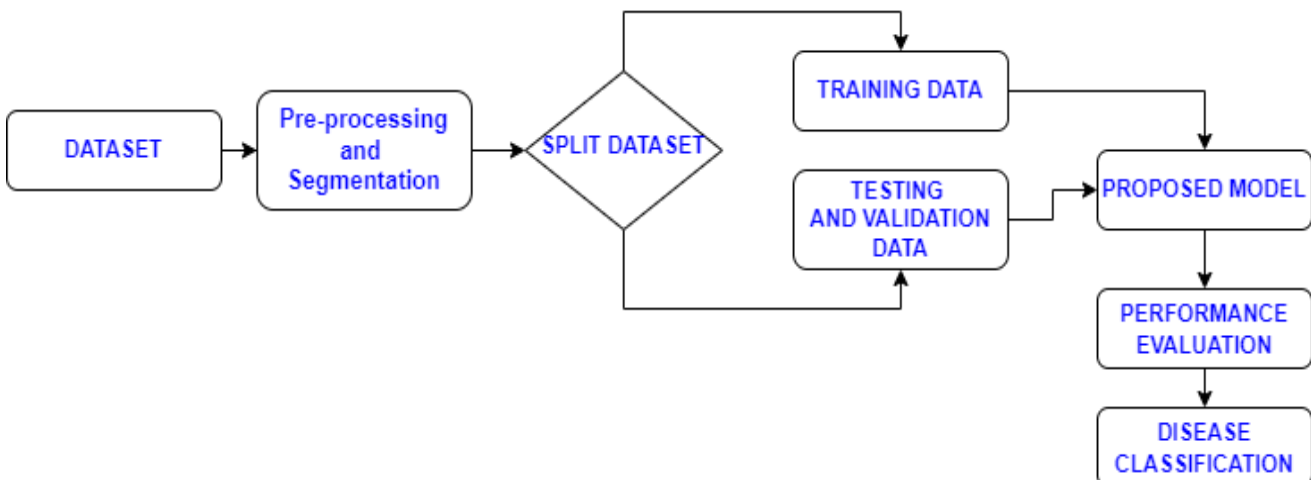

Figure 4. Methodology Flow Graph

Table II. Deep Neural Network Description.

Hyper Parameter	Description
No. of Con. Layer	15
No. of Max Pooling Layer	15
Dropout rate	0.25, 0.5
Network Weight Assigned	Uniform
Activation Function	Relu
Learning rates	0.001, 0.01, 0.1
Epoch	50, 100, 200, 250
Batch Sizes	32, 50, 60, 100

3.3.2 Pooling Layer:

Using max pooling layers can mitigate the exponential increase in network parameters caused by many convolution layers. We can use pooling layers to decrease the massive feature map produced by the convolution layer. The layer's job is to find promising features in the feature map and pull them out. We use the feature map's absolute maximum when calculating this layer's value. As a bonus, the pooling layer can help make translations more robust. To begin, the maximum pooling in Region R is equivalent to the average pooling in other regions.

$$M_p = \max_{i \in R_j}(x_i) \quad (2)$$

$$A_p: \left\{ \frac{x_i}{\sum_{i \in R_j} x_i} \right\} \quad (3)$$

Two-stage kernel sizes and pooling are necessary. The highest values are depicted on the map in the upper left corner, while the middle represents the average value obtained by adding all four values together.

Prior-trained models generate a fixed feature vector by running image segments through a convolution and pooling layer. Color, texture, and form are the usual characteristics mined by computers. After processing an image using previously trained models, a feature vector will be generated. This technique is applied to the diagnosis of plant diseases. To maximize characteristics for disease identification in leaves, a fully linked layer uses the feature vector.

3.3.3. Fully Connected Layer

The detection and classification operations are completed by the FC layer, which follows the max pooling layer. The second-to-last layer is masked using probability dropout to prevent overfitting. The final classification is depicted as follows:

$$\hat{t} = \mu(x_I (h_s \otimes I) + w_I) \quad (4)$$

Hence, DNN Qc, which can mean bacterial blight, leaf blast, or brown spot, is the categorized result.

The primary focus of the model is to unearth hidden information. Your prediction will likely only be about 50% accurate here. Overfitting is a serious problem in neural networks, no doubt about it. However, the

overfitting problem can be mitigated by utilizing regularization techniques to overcome insufficient data or a larger dataset than the network can handle. Table II displays the two regularization procedures used in this paper, augmentation, and dropout, to combat Overfitting.

4. RESULT ANALYSIS AND DISCUSSION

4.1 Determine the Number of Epochs

Quantity epochs' potential impact on system performance is the focus of current testing efforts. The tests use epoch 50 and 100 for comparison and rates of leanings are 0.0001. In Fig. 5, the test is shown.

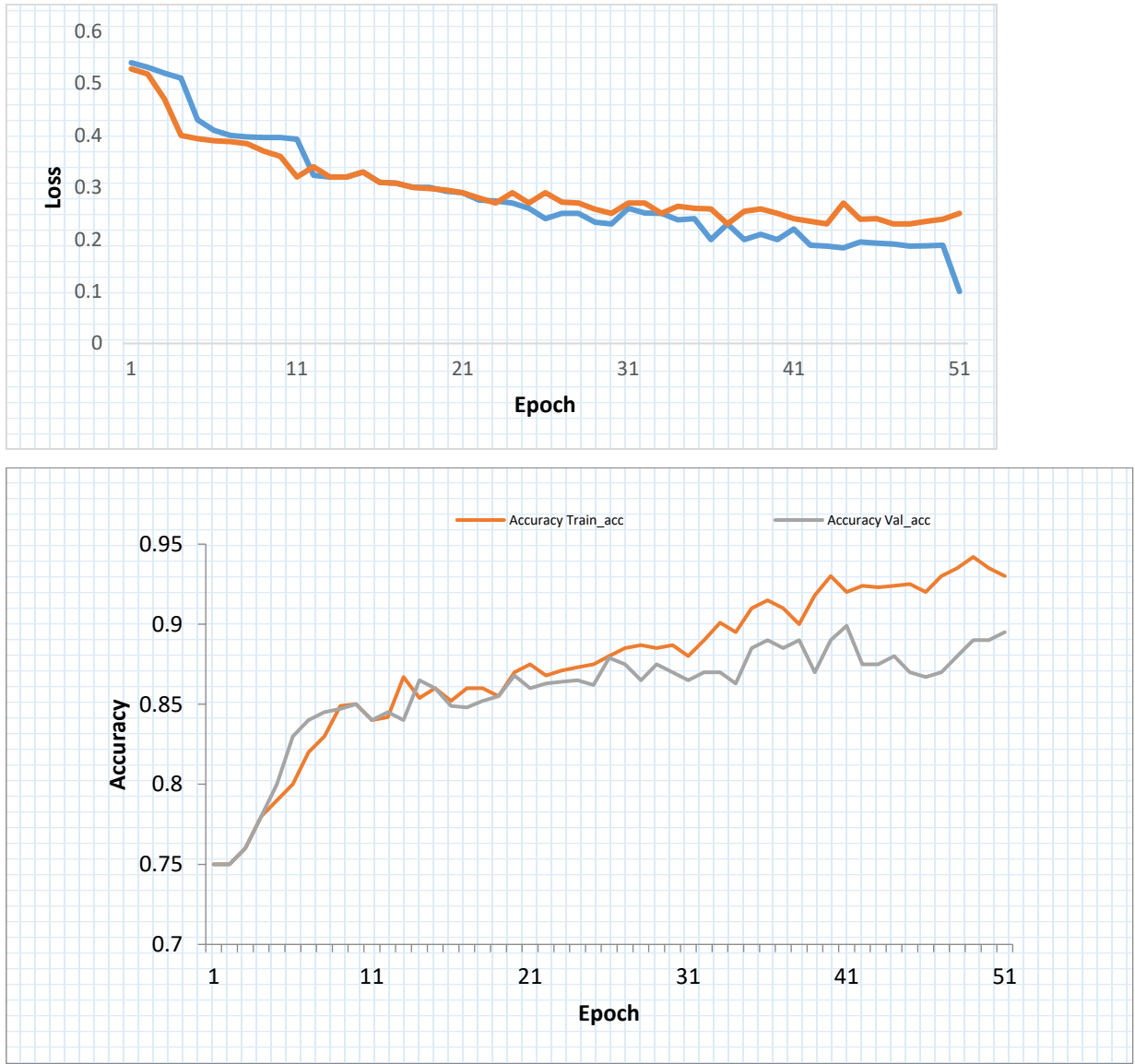

Figure 5. Training accuracy and loss rate at 0.0001 with epoch 100

With 50 epochs of training and a learning rate of 0.0001, as shown in Fig. 5, the accuracy rate is 98.2%.

According to Fig. 6, a precision rate of 98.32% is attained with the training stage 100 epoch and a learning rate of 0.0001. Based on the testing method, it may be extrapolated that more epochs are more dependable. However, the higher the epoch frequency, the longer it takes to finish the training.

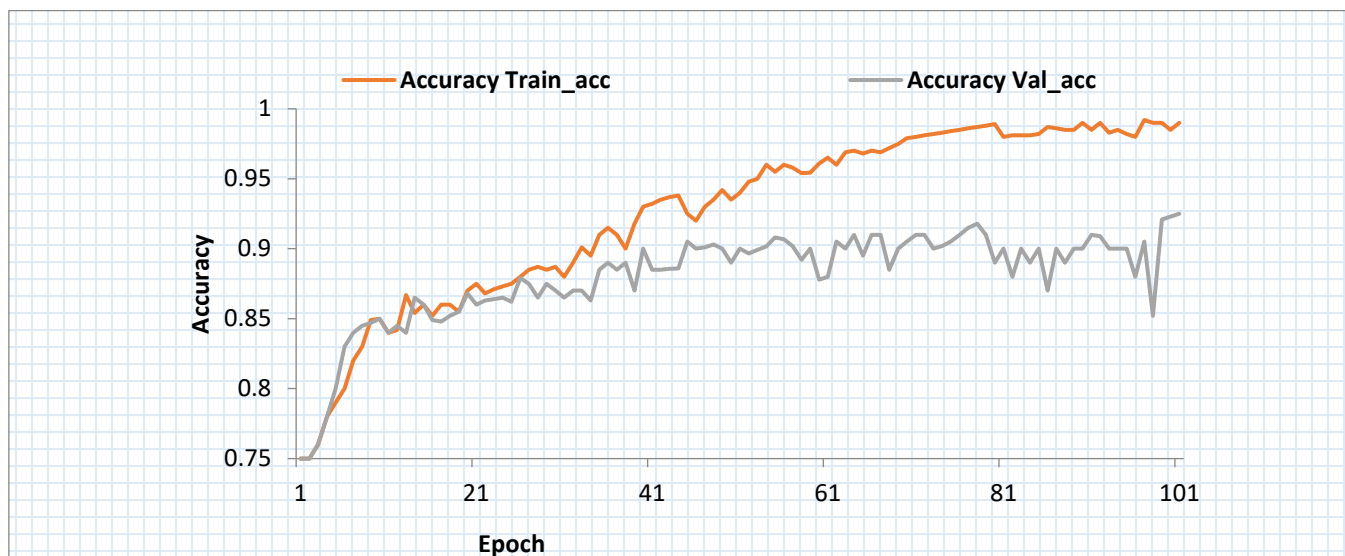

Figure 6. Learning rate of 0.0001 with training accuracy and loss at epoch 100

4.2 Determine the Rate of learning

An evaluation was done on how much learning affects machine efficiency. One of the training parameters is the learning rate for estimating the weight correction value (1). In this test, 50 and 100 epochs are employed instead of 0.001 and 0.01. Fig. 7 shows the outcomes of the tests.

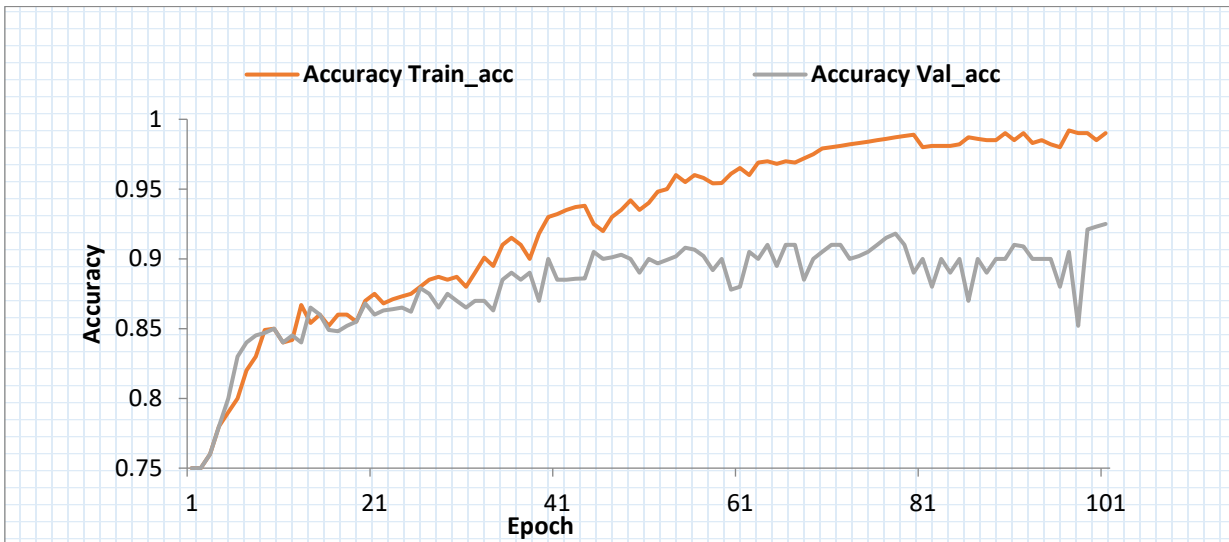
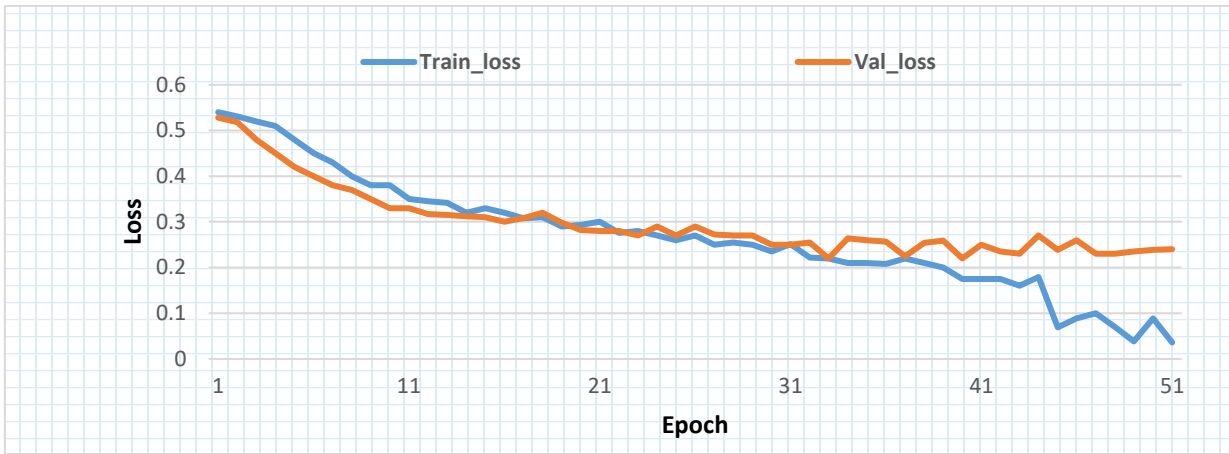
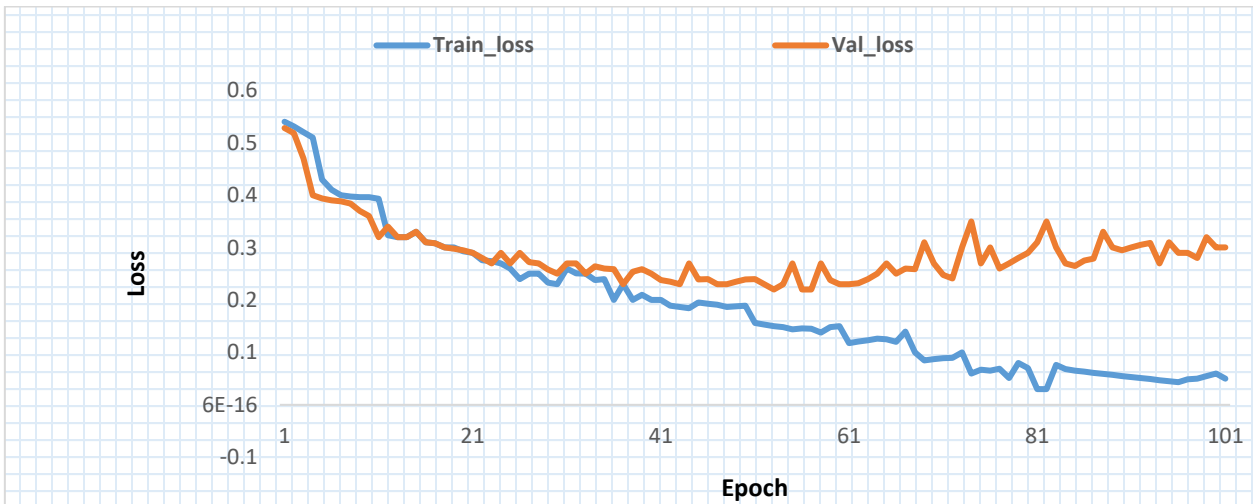

Figure 7. Accuracy of training at epoch 50 and learning rate 0.001

Based on Fig. 7, the test shows a precision rate of 98.37% in epoch 50 and a learning rate of 0.001.



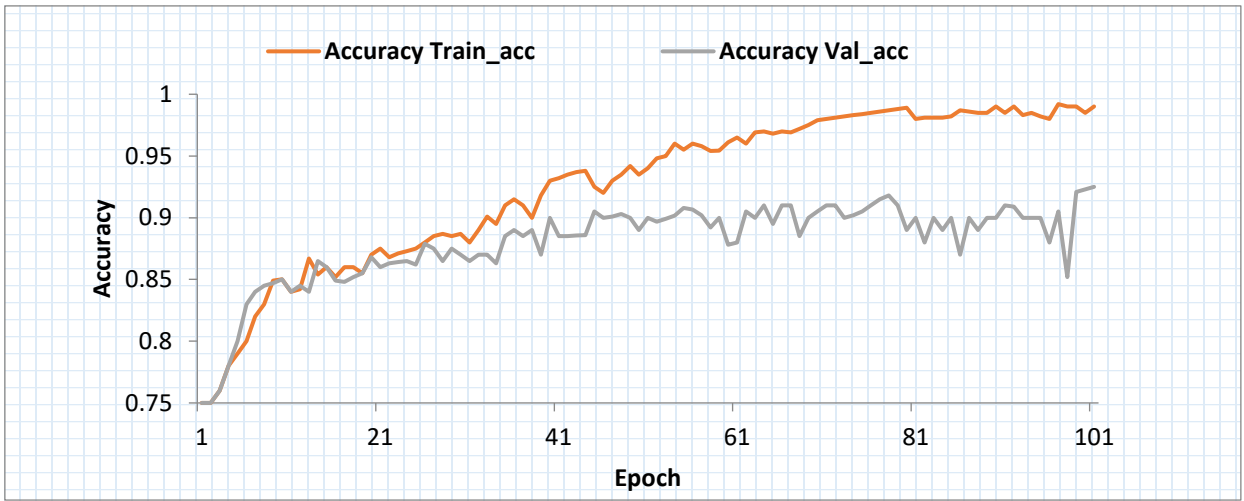

Figure 8. Learning rate of 0.001 with training accuracy and loss at epoch 100

Based on Fig. 8, the test shows a precision rate of 98.61% in epoch 100 and a learning rate of 0.001. Based on Fig. 9, the test shows a precision rate of 99.1% in epoch 50 and a rate of learning of 0.01.

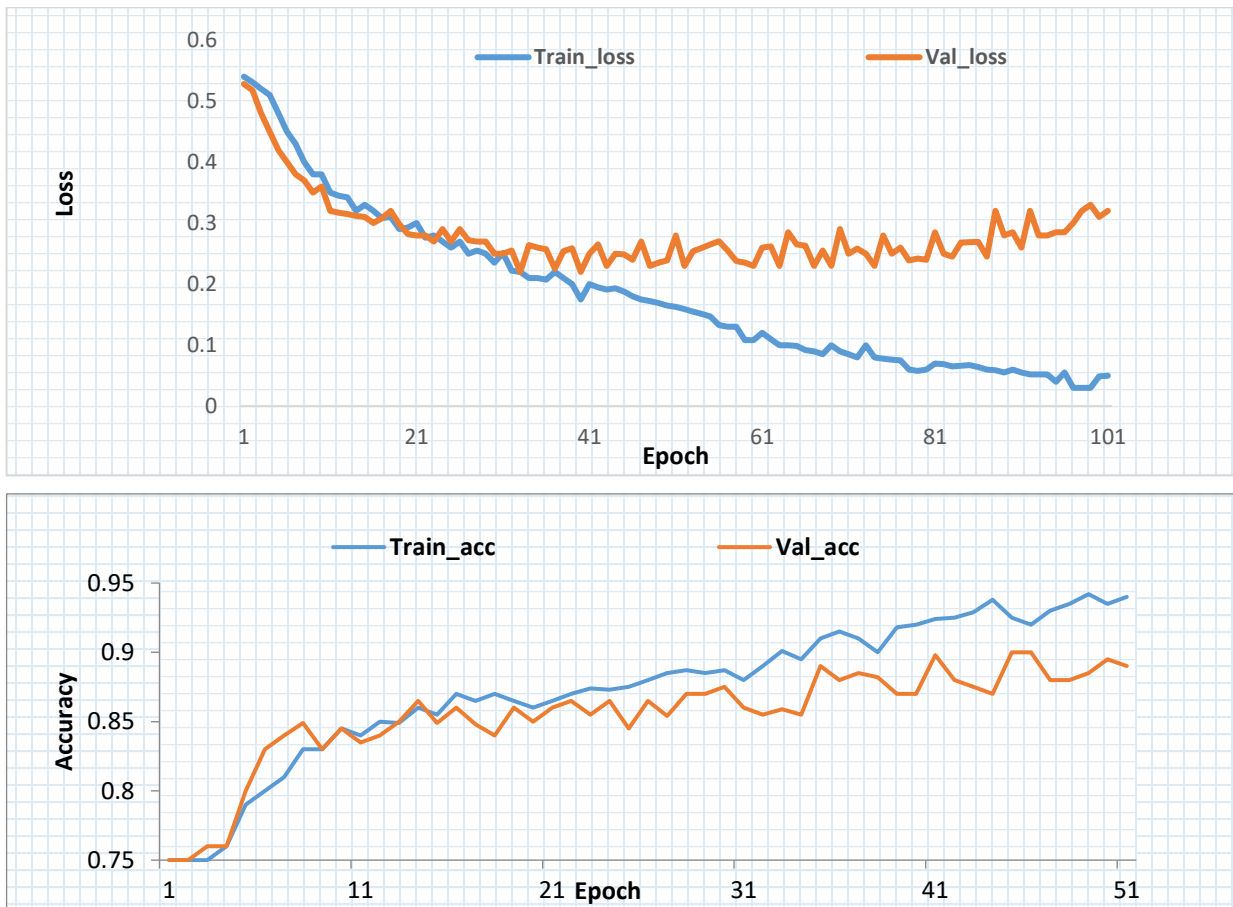

Figure 9. Learning rate of 0.01 with training accuracy and loss at epoch 50

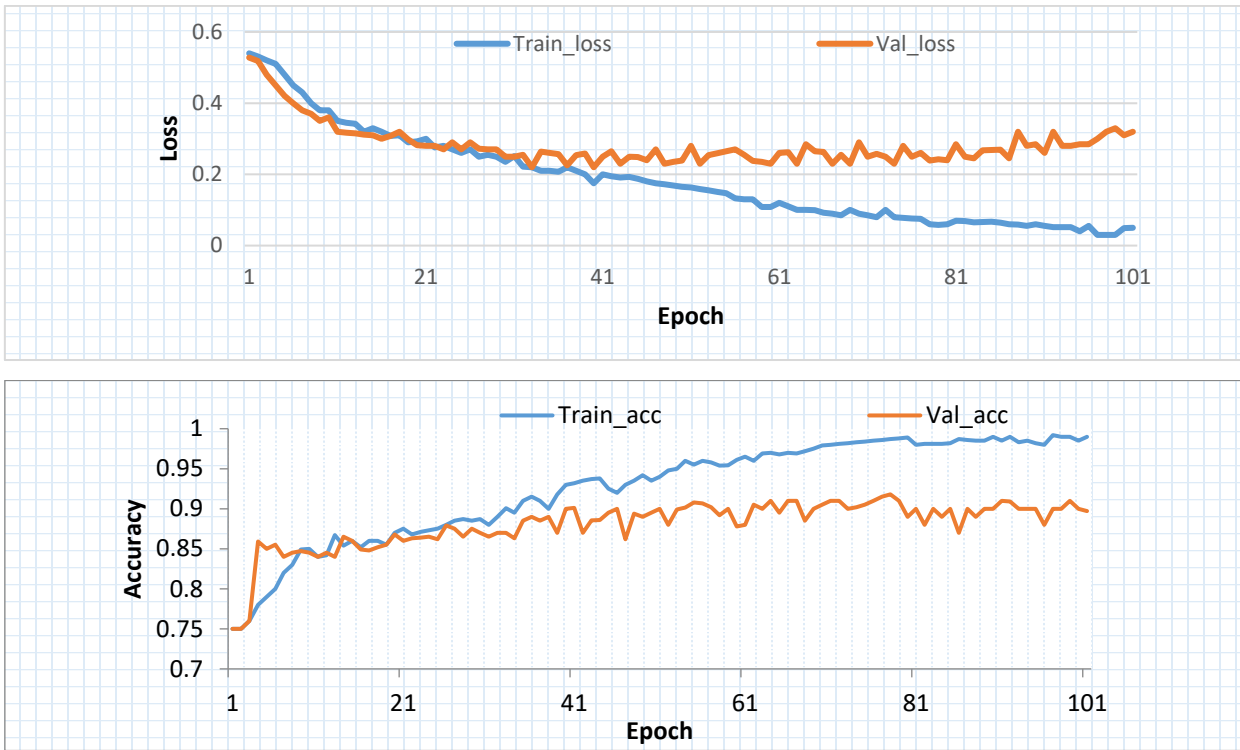

Figure 10. Learning rate of 0.01 with training accuracy and loss at epoch 100

In the 100-epoch training stage, a precision rate of 99.31% and a learning rate of 0.01 are achieved (see Fig. 9). A higher pace of learning yielded a higher percentage of accurate data, as seen in the testing phase.

Table III. Test Result

No. of Data set	Image Size	No. of Epoch	Rate of Learning	Accuracy (%)
3297	256 x 256 px	50	0.0001	98.20%
		50	0.001	98.37%.
		50	0.01	99.1%%
		100	0.0001	98.32%
		100	0.001	98.61%
		100	0.01	99.31%.

The result demonstrates that the ranking of accuracy is based on the metrics of learning rate and epoch. A better outcome can be expected from using a more trustworthy epoch value. Cross-validation is a metric to assess the quality of a model's predictions. The models' efficacy was the target of this investigation. Each subset of the data is tested many times after being separated into k groups. The kth subset is used for training in each cycle, whereas the k-1st subset is evaluated afterwards. Five to twenty rounds of model testing are normal in cross-validation. Table IV displays the results of cross validating the five models across 20

iterations. The five models vary in accuracy by around 15% throughout all iterations. Fig. 5's scatter plot shows that the proposed model consistently outperforms the alternatives across many iterations, with an overall accuracy of 99.3%. AdaBoost's 84.4% accuracy is the least of the five models. CNN comes out on top, with greater projected accuracy than any other models save AdaBoost.

Table IV. Comparison of different models

Dataset used	Model	Number of folds	Accuracy	F1 score	Precision	Recall
Grapes Leaves [88]	Proposed Model	5	0.988	0.988	0.988	0.988
	VGG19		0.981	0.981	0.981	0.981
	VGG16		0.982	0.982	0.982	0.982
	Squeeze Net		0.986	0.986	0.986	0.986
	Mobile Net		0.9574	0.9578	0.9588	0.95
	Proposed Model	10	0.991	0.991	0.991	0.991
	VGG19		0.887	0.983	0.983	0.983
	VGG16		0.983	0.983	0.983	0.983
	SqueezeNet		0.987	0.987	0.987	0.987
	Mobilenet		0.95	0.95	0.9585	0.95
	Proposed Model	20	0.993	0.993	0.993	0.993
	VGG19		0.983	0.983	0.983	0.983
	VGG16		0.984	0.984	0.984	0.984
	SqueezeNet		0.987	0.987	0.987	0.987
	Mobile Net		0.968	0.968	0.9688	0.968

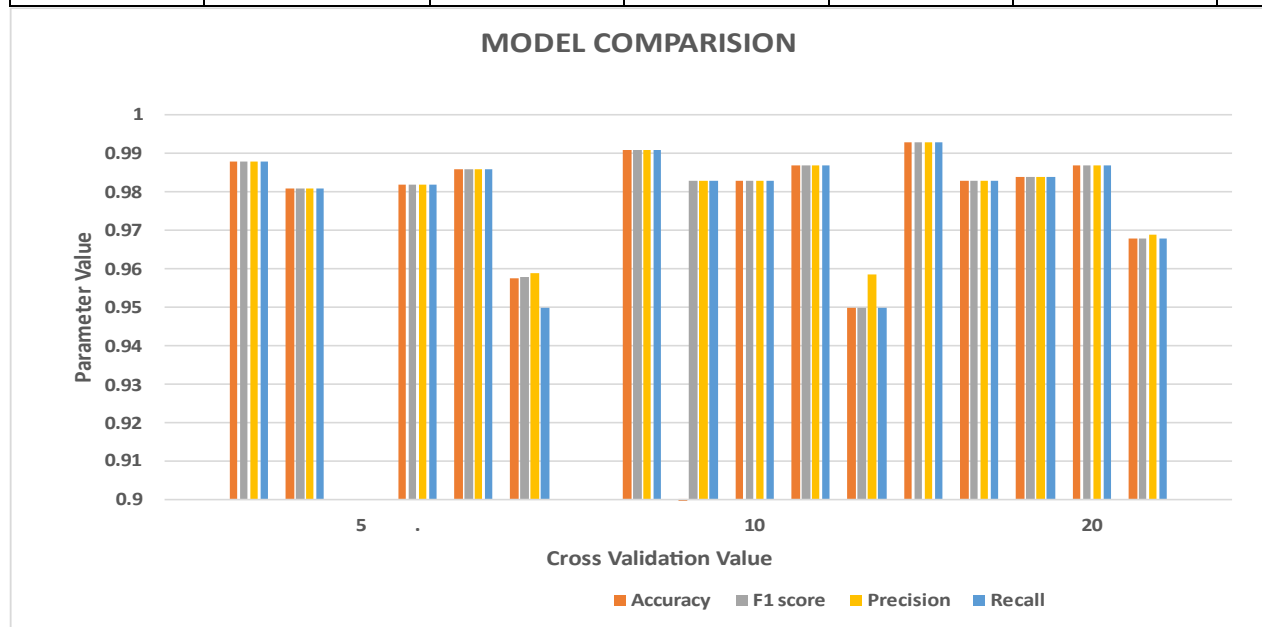

Figure 11. Graph for comparison of different model with proposed model

Diseases were discovered and predicted using a collection of 3,297 grape leaf images. We created and used five unique deep-learning models as classifiers from the outset. Predictions and evaluations were made using the models of deep learning programmes. Table IV summarises the results of a 20-fold cross-validation test for recall, accuracy, and precision for all deep learning application models. A precise AUC (Area under the Curve) of 1 would indicate that a predictive or classifying test is 100% accurate. The outcomes indicate that AUC optimisation yielded a value of 0.9997%. Thus, CNN's research plan can diagnose and categorise grape leaf diseases. Sample collection took time and labour, making using lab data to predict future diseases hard. Nonetheless, Inception V3 had the highest recall, f1-score, and accuracy for predicting leaves (all 99.3%). Considering Inception V3's suitability for a high-level image processing function, this is expected.

We utilised a training/test split of 80%/20% to determine each algorithm's effectiveness. In artificial intelligence, the k-fold cross-validation approach is frequently utilised for disease classification and identification studies, even with very small and medium data sets. Neural Network had the highest AUC (99.97%), accuracy (99.30%), f1-score (99.3%), precision (99.3%), and recall (99.3%) when predicting leaves using 20-fold cross-validation. There was a train-test split evaluation of each deep learning model. The linear distribution of the suggested model and the confusion matrix are displayed in Table V (Number of instances).

Table V. Matrix of confusion for the suggested model

	“Grape Black rot”	“Grape Esca (Black_Measles)”	“Grape Leaf blight (Isariopsis Leaf Spot)”	“Grape healthy”	Σ
“Grape Black rot”	98.6 %	0.9 %	0.0 %	0.1 %	843
“Grape Esca (Black_Measles)”	1.3 %	98.9 %	0.0 %	0.0 %	852
“Grape Leaf blight (Isariopsis Leaf Spot)”	0.0 %	0.0 %	100.0 %	0.1 %	762
“Grape healthy”	0.1 %	0.1 %	0.0 %	99.8 %	840
Σ	846	850	761	840	3297

The percentage breakdown of Table V's confusion matrix is shown in Fig.11. Grape black rot had a TP rate of 98.6%, Grape esca black measles at 98.9%, Grape leaf blight at 100%, and 99.8% overall (Grape healthy). A confusion matrix evaluates many metrics, including accuracy, precision, sensitivity, error rate, and specificity. The results are expressed as a percentage: Fig. 12 shows the suggested model's ROC (receiver operating characteristic curve).

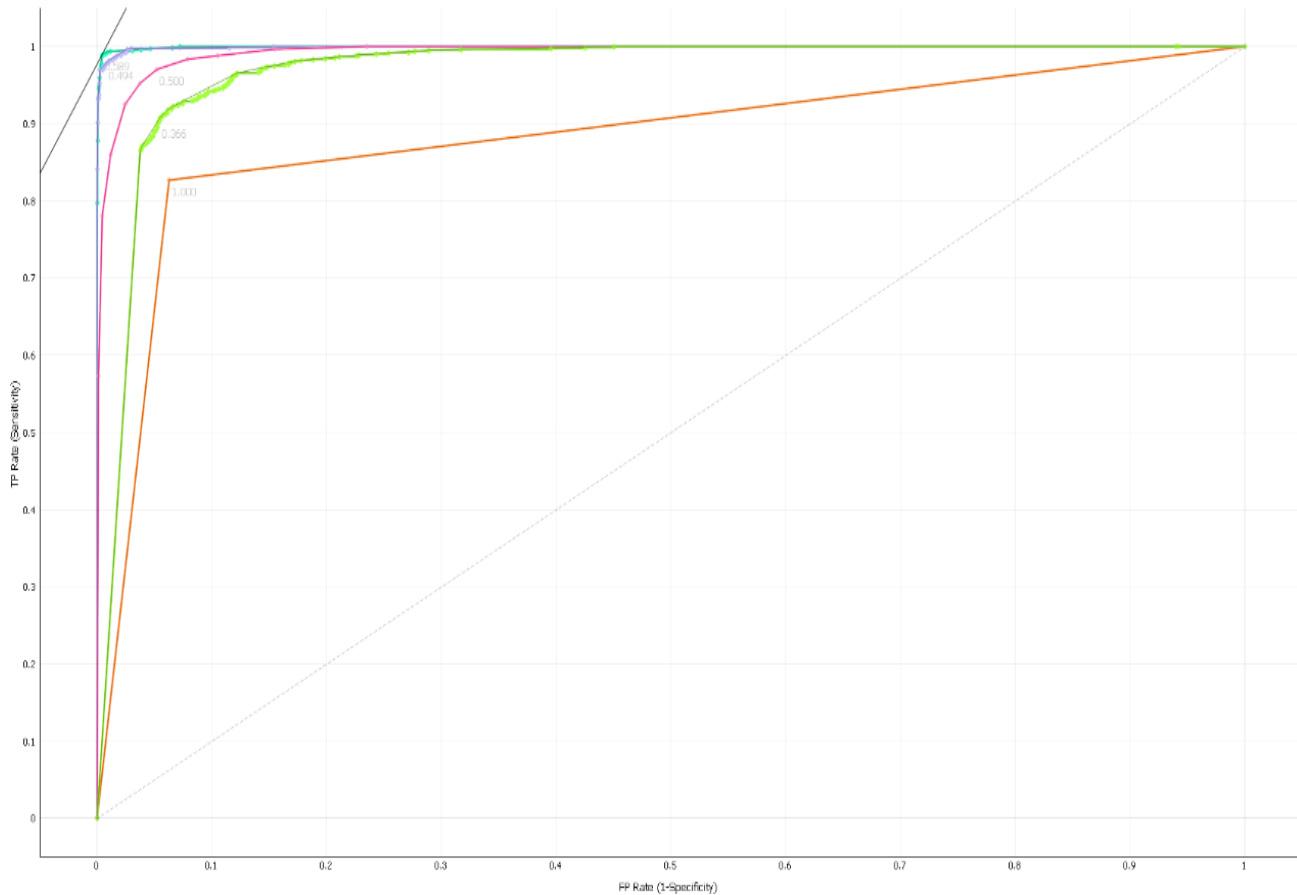

Figure 12. ROC curve for Proposed model with k fold 20

Scatter plot for proposed model architectures is shown in Fig. 13 below. It is clearly visible in scatter plot that the proposed model scatter plot k fold 20 is better than other models.

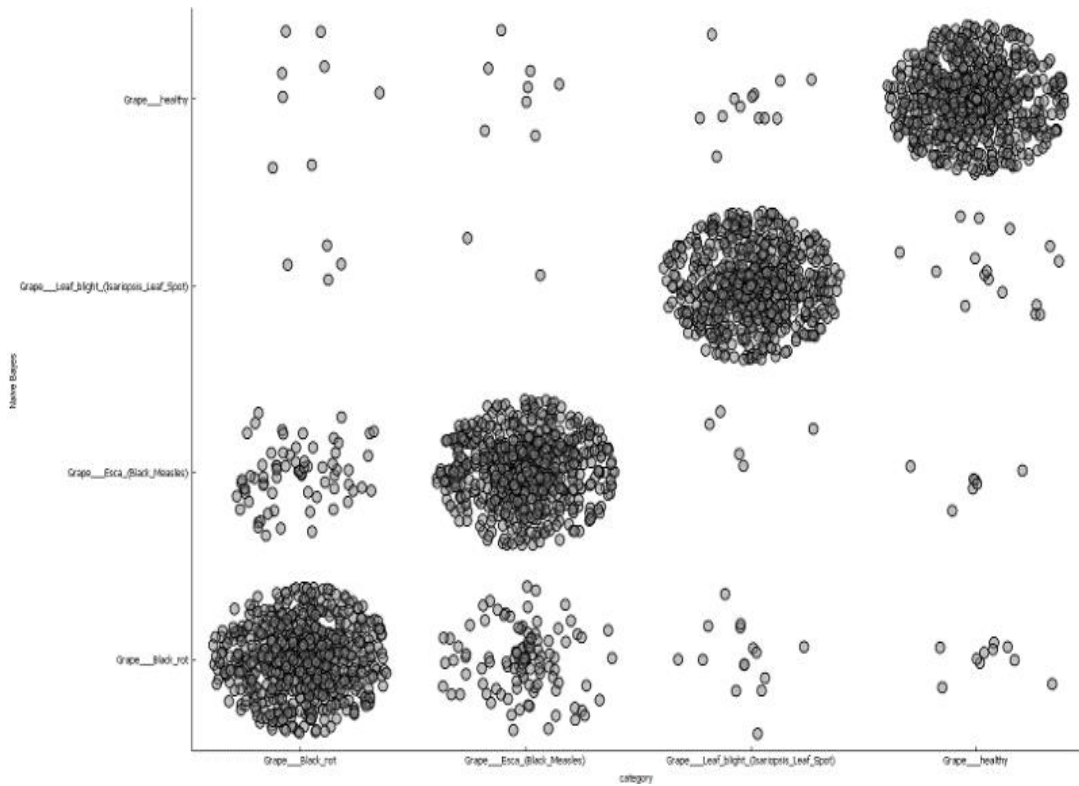

Figure 13. Scatter plot for proposed model k fold 20

Model F1, Precision, and Recall Graph with Variable Classifiers: The suggested model outperforms the other models in terms of F1 score, Recall, and, Precision as shown in Fig. 14.

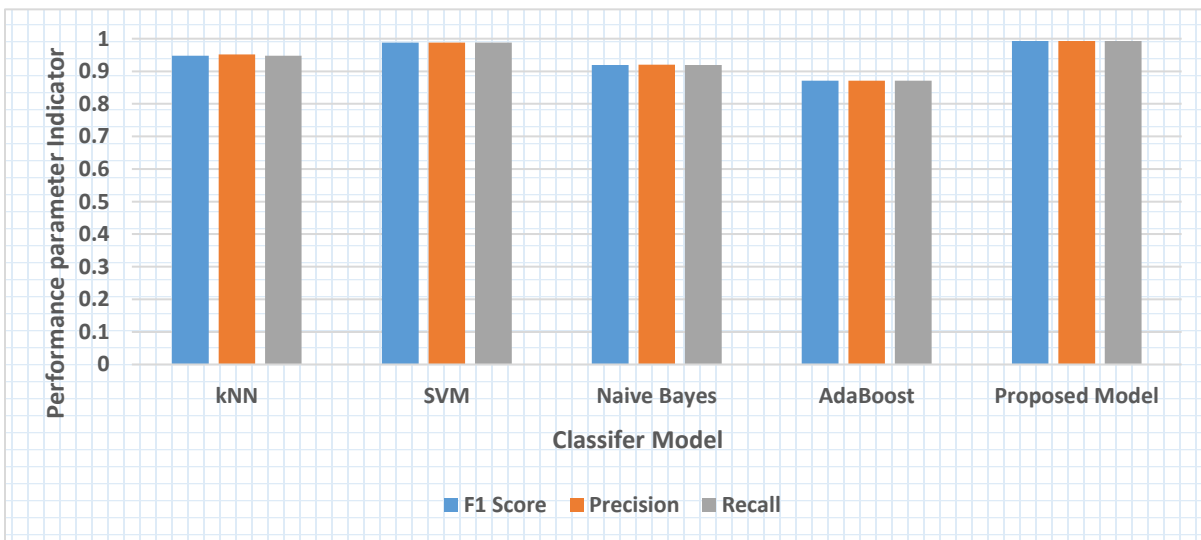

Figure 14. Comparison against other classifiers

5. CONCLUSION AND FUTURE WORK

Academic interest in artificial neural networks (ANNs) has been revitalized by the tremendous progress in image processing and image applications using CNN. This research uses important transfer learning models such as the Squeeze net, VGG16, and VGG19 network and the Suggested model to classify leaf illnesses. Numerous advancements are underway to increase such applications' performance by using CNNs. For this

analysis, we focused on the relationship between grape vegetable species and leaf diseases. This paper's proposed model has a prediction accuracy of 99.3%. Based on the experimental findings, a new model with more layers and original data added to incoming layers improves prediction accuracy. The networks' capacity to use the available data is enhanced as a result. Future predictions based on real-time data will be more accurate with the use of appropriate pre-processing procedures.

The model will be expanded to recognize the impact of multiple pathogens on a plant leaf or a combination of pathogens. We will take multiple diseases into account during the study. We will also investigate whether abiotic causes, such as nutritional levels, have a role in the development of leaf diseases.

REFERENCES

- [1] W. M. N. Wan Mohd Fadzil, M. S. B. Shah Rizam, R. Jailani, and M. T. Nooritawati, "Orchid leaf disease detection using border segmentation techniques," in 2014 IEEE Conference on Systems, Process and Control (ICSPC 2014), 2014, pp. 168–173. doi: 10.1109/SPC.2014.7086251.
- [2] Parikh, M. S. Raval, C. Parmar, and S. Chaudhary, "Disease Detection and Severity Estimation in Cotton Plant from Unconstrained Images," in 2016 IEEE International Conference on Data Science and Advanced Analytics (DSAA), 2016, pp. 594–601. doi: 10.1109/DSAA.2016.81.
- [3] B. S. Prajapati, V. K. Dabhi, and H. B. Prajapati, "A survey on detection and classification of cotton leaf diseases," in 2016 International Conference on Electrical, Electronics, and Optimization Techniques (ICEEOT), 2016, pp. 2499–2506. doi: 10.1109/ICEEOT.2016.7755143.
- [4] M. Sardogan, A. Tuncer, and Y. Ozen, "Plant Leaf Disease Detection and Classification Based on CNN with LVQ Algorithm," in 2018 3rd International Conference on Computer Science and Engineering (UBMK), 2018, pp. 382–385. doi: 10.1109/UBMK.2018.8566635.
- [5] N. M. Yusoff, I. S. Abdul Halim, N. E. Abdullah, and A. A. Ab. Rahim, "Real-time Hevea Leaves Diseases Identification using Sobel Edge Algorithm on FPGA: A Preliminary Study," in 2018 9th IEEE Control and System Graduate Research Colloquium (ICSGRC), 2018, pp. 168–171. doi: 10.1109/ICSGRC.2018.8657603.
- [6] R. Indumathi., N. Saagari., V. Thejuswini., and R. Swarnareka., "Leaf Disease Detection and Fertilizer Suggestion," in 2019 IEEE International Conference on System, Computation, Automation and Networking (ICSCAN), 2019, pp. 1–7. doi: 10.1109/ICSCAN.2019.8878781.
- [7] C. Khitthuk, A. Srikaew, K. Attakitmongcol, and P. Kumsawat, "Plant Leaf Disease Diagnosis from Color Imagery Using Co-Occurrence Matrix and Artificial Intelligence System," in 2018 International Electrical Engineering Congress (iEECON), 2018, pp. 1–4. doi: 10.1109/IEECON.2018.8712277.
- [8] B. Zhao, X. Li, X. Lu, and Z. Wang, "A CNN-RNN Architecture for Multi-Label Weather Recognition," CoRR, vol. abs/1904.10709, 2019, [Online]. Available: <http://arxiv.org/abs/1904.10709>

- [9] R. U. Khan, K. Khan, W. Albattah, and A. M. Qamar, "Image-Based Detection of Plant Diseases: From Classical Machine Learning to Deep Learning Journey," *Wireless Communications and Mobile Computing*, vol. 2021, p. 5541859, 2021, doi: 10.1155/2021/5541859.
- [10] A. Krizhevsky, I. Sutskever, and G. E. Hinton, "ImageNet Classification with Deep Convolutional Neural Networks," *Commun. ACM*, vol. 60, no. 6, pp. 84–90, May 2017, doi: 10.1145/3065386.
- [11] G. Kuricheti and P. Supriya, "Computer Vision Based Turmeric Leaf Disease Detection and Classification: A Step to Smart Agriculture," in *2019 3rd International Conference on Trends in Electronics and Informatics (ICOEI)*, 2019, pp. 545–549. doi: 10.1109/ICOEI.2019.8862706.
- [12] Kamilaris, A., Prenafeta-Boldú, F.X., 2018. Deep learning in agriculture: a survey. *Comput. Electron. Agric.* 147, 70–90. <https://doi.org/10.1016/J.COMPAG.2018.02.016>.
- [13] Wang, H., Li, G., Ma, Z., and Li, X. (2012). "Image recognition of plant diseases based on principal component analysis and neural networks," in *Proceedings of the 8th International Conference on Natural Computation*, Okinawa Prefecture, 246–251.
- [14] Sannakki, S. S., Rajpurohit, V. S., Nargund, V. B., and Kulkarni, P. (2013). "Diagnosis and classification of grape leaf diseases using neural networks," in *Proceedings of the Fourth International Conference on Computing, Communications and Networking Technologies*, Tiruchengode, 1–5.
- [15] Shukla, P.K., Sandhu, J.K., Ahirwar, A., Ghai, D., Maheshwary, P. and Shukla, P.K., 2021. Multiobjective genetic algorithm and convolutional neural network based COVID-19 identification in chest X-ray images. *Mathematical Problems in Engineering*, 2021, pp.1-9.
- [16] Lilhore, U.K., Poongodi, M., Kaur, A., Simaiya, S., Algarni, A.D., Elmannai, H., Vijayakumar, V., Tunze, G.B. and Hamdi, M., 2022. Hybrid model for detection of cervical cancer using causal analysis and machine learning techniques. *Computational and Mathematical Methods in Medicine*, 2022.
- [17] Ferentinos, K. P. (2018). Deep learning models for plant disease detection and diagnosis. *Comput. Electron. Agric.* 145, 311–318. doi: 10.1016/j.compag.2018.01.009
- [18] Rançon, F., Bombrun, L., Keresztes, B., and Germain, C. (2018). Comparison of SIFT encoded and deep learning features for the classification and detection of esca disease in bordeaux vineyards. *Remote Sens.* 11:1. doi: 10.3390/rs11010001
- [19] H. Zhu, Q. Liu, Y. Qi, X. Huang, F. Jiang, and S. Zhang, "Plant identification based on very deep convolutional neural networks," *Multimedia Tools and Applications*, vol. 77, no. 22, pp. 29779–29797, 2018, doi: 10.1007/s11042-017-5578-9.
- [20] Fuentes, A., Yoon, S., Kim, S. C., and Park, D. S. (2017). A robust deep-learningbased detector for real-time grape plant diseases and pests recognition. *Sensors* 17:2022. doi: 10.3390/s17092022
- [21] P. Jiang, Y. Chen, B. Liu, D. He, and C. Liang, "Real-Time Detection of Apple Leaf Diseases Using Deep Learning Approach Based on Improved Convolutional Neural Networks," *IEEE Access*, vol. 7, pp. 59069–59080, 2019, doi: 10.1109/ACCESS.2019.2914929.

- [22] Z. and W. H. Li Guanlin and Ma, "Image Recognition of Grape Downy Mildew and Grape Powdery Mildew Based on Support Vector Machine," in *Computer and Computing Technologies in Agriculture V*, 2012, pp. 151–162.
- [23] G Athanikar and Ms. P. Badar, "Potato Leaf Diseases Detection and Classification System Mr," 2016.
- [24] H. Zhu, Q. Liu, Y. Qi, X. Huang, F. Jiang, and S. Zhang, "Plant identification based on very deep convolutional neural networks," *Multimedia Tools and Applications*, vol. 77, no. 22, pp. 29779–29797, 2018, doi: 10.1007/s11042-017-5578-9.
- [25] Trivedi, N.K., Gautam, V., Anand, A., Aljahdali, H.M., Villar, S.G., Anand, D., Goyal, N. and Kadry, S., 2021. Early Detection and Classification of Tomato Leaf Disease Using High-Performance Deep Neural Network. *Sensors*, 21(23), p.7987.
- [26] S. H. Lee, C. S. Chan, P. Wilkin, and P. Remagnino, "Deep-Plant: Plant Identification with convolutional neural networks," *CoRR*, vol. abs/1506.08425, 2015, [Online]. Available: <http://arxiv.org/abs/1506.08425>
- [27] C. Szegedy, S. Ioffe, and V. Vanhoucke, "Inception-v4, Inception-ResNet and the Impact of Residual Connections on Learning," *CoRR*, vol. abs/1602.07261, 2016, [Online]. Available: <http://arxiv.org/abs/1602.07261>
- [28] N. Kussul, M. Lavreniuk, S. Skakun, and A. Shelestov, "Deep Learning Classification of Land Cover and Crop Types Using Remote Sensing Data," *IEEE Geoscience and Remote Sensing Letters*, vol. 14, no. 5, pp. 778–782, 2017, doi: 10.1109/LGRS.2017.2681128.
- [29] X. Liu, W. Min, S. Mei, L. Wang, and S. Jiang, "Plant Disease Recognition: A Large-Scale Benchmark Dataset and a Visual Region and Loss Reweighting Approach," *IEEE Transactions on Image Processing*, vol. 30, pp. 2003–2015, 2021, doi: 10.1109/TIP.2021.3049334.
- [30] Tiwari, R.G., Misra, A. and Ujjwal, N., 2022, December. Image Embedding and Classification using Pre-Trained Deep Learning Architectures. In *2022 8th International Conference on Signal Processing and Communication (ICSC)* (pp. 125-130). IEEE.
- [31] Tiwari, R.G., Husain, M., Gupta, B. and Agrawal, A., 2010, November. Amalgamating contextual information into recommender system. In *2010 3rd international conference on emerging trends in engineering and technology* (pp. 15-20). IEEE.