

# A collective review of Terahertz technology integrated with a newly proposed split learning-based algorithm for healthcare system

Sambit Satpathy, Osamah Khalaf, Dhirendra Kumar Shukla,  
Mohit Chowdhary, Sameer Algburi

**Abstract**—The Now a days, Terahertz (THz) imaging can be used to improve healthcare in several ways. Firstly, THz imaging can be used for cancer detection, allowing for early detection before visible symptoms appear. THz imaging can distinguish between healthy tissue and cancerous tissue, providing sharper imaging and molecular fingerprinting. Furthermore, THz imaging can be integrated with artificial intelligence, internet of things, cloud computing, and big data analytics to create more sophisticated healthcare systems. Split learning is a privacy-preserving method that collectively with deep learning method used in the healthcare system to train collaborative models without sharing raw patient data between clients. Split learning algorithms, occur when training models sequentially, making them more robust and effective. Multi-site split learning is a novel algorithm that enables secure data transfer between hospitals, ensuring privacy while achieving optimal performance. To full fill this objective here we have review various THz technology on the healthcare system and introduced a machine learning with a split learning based secured method, that has the potential to revolutionize healthcare by enabling early detection, improving diagnostics, and facilitating personalized treatment approaches. The article also associate with various review algorithm's potential impact on compact and portable consumer devices, such as smartphones and wearable health trackers, which may applicable on real life.

**Index Terms**—AI, medical imaging, Terahertz technology, Consumer electronics, split learning

## I. INTRODUCTION

The investigation into cutting-edge thermal sensors, similar to those employed in nocturnal vision cameras, has garnered considerable attention. Pioneering strides in semiconductor processing technologies and the evolution of inventive materials have opened up novel frontiers in infrared (thermal) detectors [1]. Terahertz (THz) technology, operating within the frequency range of 0.3 to 3 THz [2], harnesses the power of thermal radiation and offers exceptional advantages across various domains. Unlike shorter wavelengths (millimeter waves) that struggle to penetrate materials, THz waves possess the ability to penetrate deep into matter, enabling high-resolution imaging. Moreover, THz waves exhibit properties such as non-ionization and low photon energies, ensuring they do not trigger detrimental reactions in tissues [3-4]. The applications of THz technology are vast and encompass high-speed mobile and wireless communications, environmental monitoring, security and surveillance for the detection of explosives and hazardous materials, biomedical and healthcare applications, drug delivery, T-ray vision, material inspection, and even remote sensing of interstellar materials and planets [5-6].

Although significant innovations have been made in THz technology since 2010, particularly in powerful sources, un-

cooled detectors, and real life/ real-time imaging, there are fundamental challenges to be addressed before these systems can be commercially viable and seamlessly integrated into flexible electronics [6-8]. The present path of the THz field is inclined towards an interdisciplinary methodology that is stimulated by the pragmatic requirements of commonplace commercial systems. This emphasizes the importance of scrutinizing innovative and resilient Terahertz sources, prompt and reactive sensors, and effective optical components [9-10]. This piece of work thoroughly investigates the emerging developments in THz systems that occur at the intersection of artificial intelligence (AI), wearable devices, and the Internet of Things (IoT). These state-of-the-art technologies possess the potential to transform numerous fields, particularly the biomedical and healthcare industry. The objective of this chapter is to enable individuals venturing into the realm of medical applications of THz to gain a comprehensive understanding by providing a detailed review of theoretical (see fig.1), methodological, and empirical advancements in the implementation of AI, IoT, and wearable devices in THz biomedical and healthcare technologies. A wide range of people, from students to specialists in engineering and technology, can benefit from the information. [11].

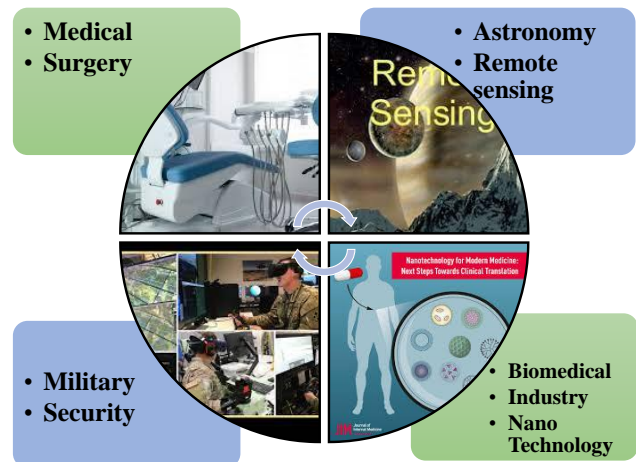

Fig.1. The utilization of terahertz technology plays a significant role in a myriad of applications.

## II. PRIOR LITRATURE REVIEW

Converging technologies in healthcare, such as Artificial Intelligence (AI), Internet of Things (IoT), blockchain, and big data, are playing a crucial role in transforming the healthcare system and improving patient care [12-13]. These technologies are being used for various purposes, including pandemic management, surveillance, contact tracing, diagnosis, treatment, and prevention of diseases like COVID-19 [14]. They are also enabling the development of smart healthcare solutions that empower individuals to manage their own health and provide accurate and effective treatment and diagnosis. Additionally, emerging technologies are helping in the analysis and improvement of healthcare processes, leading to better healthcare outcomes. The integration of these technologies has the potential to revolutionize healthcare delivery, improve the quality of services, and reduce costs, ultimately transforming the society [15]. Split learning, a distributed machine learning method, has been applied in the medical field by many researcher [16- 17] to address the shortage of labeled data and the challenges of sharing patient information openly. It has been compared to centrally hosted and non-collaborative configurations for two medical deep learning tasks. The results show that the performance of split learning remained constant for any number of clients, indicating its benefits in collaborative training of deep neural networks in healthcare [16]. Additionally, a Split Artificial Intelligence Architecture (SAIA) has been proposed for mobile healthcare systems, which combines cloud computing infrastructure with lightweight AI solutions that work locally on the client side. SAIA consistently outperformed its baselines in terms of effectiveness and efficiency [17]. These approaches demonstrate the potential of distributed learning and split AI architectures in improving healthcare outcomes.

Terra hertz technology provide an remarkable impact on healthcare system that has been discuss by so many researcher/scientist [18-20]. Enhanced terahertz healthcare systems aim to improve medication adherence, diagnosis, and treatment efficacy through the use of multimedia technology and remote monitoring [18]. These systems consist of various components such as medicine bags, home servers, hospital servers, prescription terminals, and pharmacy servers, which enable communication and data exchange [19]. The integration of wireless communication technology allows for rapid efficacy assessment and complete health record collection [20]. Terahertz technology has shown potential in medical applications, including skin cancer detection, dental caries detection, and pharmaceutical screening [21]. However, there are still limitations and challenges that need to be addressed before terahertz technology can be widely used in clinical settings [22]. The unique properties and biophysical effects of terahertz range have been proven to be harmless and efficient in medical devices. Overall, enhanced terahertz healthcare systems have the potential to improve healthcare outcomes and patient experiences.

## III. MOTIVATION

The fusion of AI and smart terahertz technology offers an inspiring frontier in consumer electronics, particularly in healthcare applications. By converging AI's cognitive capabilities with terahertz's prowess in non-invasive imaging, a revolutionary healthcare system becomes conceivable. This integration empowers consumer electronic devices with the ability to perform advanced medical scans, enabling users to monitor their health in unprecedented ways. From detecting early stage anomalies to tracking chronic conditions, this innovation promises personalized insights and timely interventions, all conveniently accessible from the comfort of one's home. The integration of AI enhances this system's diagnostic accuracy and interpretation, making it user-friendly and reliable. The potential for wearables, smartphones, and other consumer electronics to function as health monitoring devices represents a paradigm shift in proactive healthcare. By making healthcare data readily available and actionable, individuals can take charge of their well-being like never before. In essence, the AI-based smart terahertz healthcare system for consumer electronics offers a future where empowerment and wellness intertwine seamlessly [23-25].

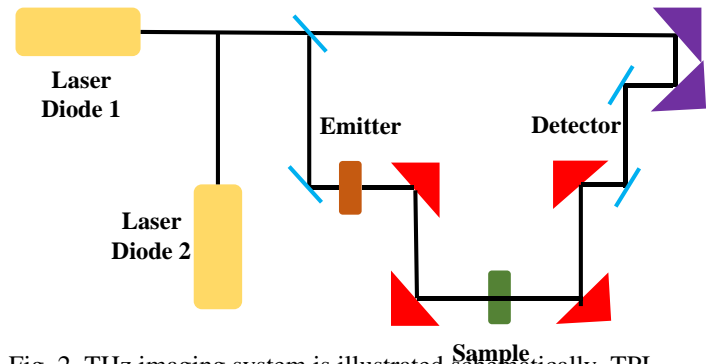

Fig. 2. THz imaging system is illustrated schematically. TPI reflection system.

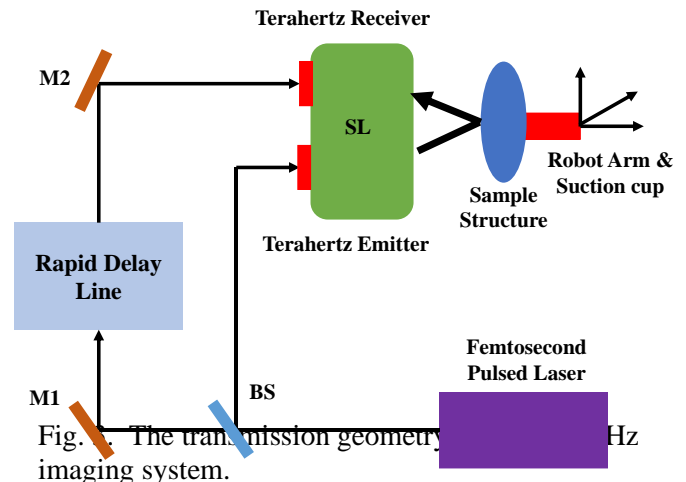

Fig. 3. The transmission geometry of THz imaging system.

## III. THE UTILIZATION OF TERAHERTZ TECHNOLOGY ON IMAGE PROCESSING AND SPECTROSCOPY

### A. Medical Imaging

The combination of AI, IoT, and the wearable technology places a high value on the study of THz spectroscopy and medical imaging. These cutting-edge tools and devices rely on data collected from various sensors, including spectroscopic and imaging sensors, to drive advancements in THz healthcare technologies. Biomedical imaging platforms can leverage different frequency bands, with THz technology's short waves being particularly useful for measuring cell size and distinguishing between affected and unaffected cells. THz technology is essential for identifying cancerous tissues and has numerous medical applications, including the diagnosis of skin cancer, wound inspection, dentistry, biopsy, blood, breath, endoscopy, breast cancer, osteoarthritis, arthritis, and multispectral Terahertz colonoscopy [26].

THz imaging offers advantages like enhanced signal-to-noise ratio, spatial resolution, and sensitivity, enabling identification of various cancer types even in their early stages through DNA analysis [27]. Moreover, THz imaging is non-invasive and provides high-resolution micrometer-scale images. Its wavelengths lie between microwaves and infrared, enabling its usage in diverse biomedical applications. Unlike X-rays, THz light does not harm the skin tissue due to its lower energy (0.41-41meV). The real-time imaging capability of THz makes it valuable during surgical operations, providing better visualization and high medical data security.

Pulsed THz imaging and continuous-wave THz imaging comprise the primary categories of THz medical imaging systems. An array of methodologies has been explored by scholars, such as the utilization of a robotic arm for freeform surface with THz imaging principles [28]. Additionally, THz medical imaging has been scrutinized in the context of nanotechnology to yield enhanced sensitivity and resolution [29]. Time-domain spectroscopy (TDS) has been used in studies to quantify the borders of breast cancer, revealing the ability to distinguish precisely between breast carcinoma, fibro glandular tissue, and adipose tissue [30]. Advantages of THz imaging include its ability to penetrate clothing with low radiation exposure. Additionally, advancements in deep learning techniques have facilitated concealed item identification in real-time using THz technology [31]. These findings showcase the transformative potential of THz spectroscopy and medical imaging in revolutionizing healthcare practices.

To yield enhanced sensitivity and resolution. Time-domain spectroscopy (TDS) has been used in studies to quantify the borders of breast cancer, revealing the ability to distinguish precisely between breast carcinoma, fibro glandular tissue, and adipose tissue. Advantages of THz imaging include its ability to penetrate clothing with low radiation exposure. Additionally, advancements in deep learning techniques have facilitated concealed item identification in real-time using THz technology [32]. These findings showcase the transformative potential of THz spectroscopy and medical imaging in revolutionizing healthcare practices.

### B. THz imaging system

In recent times, the THz imaging system has experienced remarkable progress, primarily driven by its pivotal advantages in visualization and enhanced security, particularly in the field of medicine. The THz pulsed imaging (TPI) system and the continuous-wave (CW) THz imaging system are two popular THz imaging systems that will be discussed in this context [33].

### C. THz pulsed imaging system

Imaging in both transmission and reflection modes is possible with the TPI technology. For instance, a TPI reflection system (Fig. 2) commonly uses a biased photoconductive antenna in conjunction with a femtosecond pulse laser to produce THz pulses. After that, these pulses are gathered, collimated, and directed at the sample. The THz pulses that have been backscattered and reflected are then gathered and focused onto a laser-gated photoconductive antenna. The TPI transmission system permits the ingress of THz waves into the sample, in contrast to the TPI reflection system. In TPI reflection detection, the THz waveform is documented as a function of optical time delay at each pixel, subsequent to being collected at various points over the sample surface. Owing to the vertical and horizontal dimensions being displayed on the x and y-axes, respectively, and the time-delay dimension being represented by the z-axis, the TPI system provides three-dimensional information. Despite necessitating an extended scanning period, the TPI system captures THz waveforms in the time domain, thereby capturing both intensity and phase data, making it easier to accumulate more precise information about the target [34-35].

### D. Continuous-wave THz imaging system

The CW THz imaging system is capable of imaging in both transmission and reflection modes. For instance, in a CW THz reflection imaging system illustrated in Fig. 3, two CW lasers are photo mixed in a photoconductor. The amalgamation of two wavelengths, namely near-infrared or apparent, that leads to the aforementioned beating gives rise to a modification in the conductance of the photoconductive switching at the THz difference frequency. In lieu of this, a far-infrared laser may be employed as a viable alternative. It is to be noted that the CW THz wave engenders reflections on the sample surface in the CW THz reflection imaging system, as opposed to the CW THz spread imaging system. Sometimes just intensity details can be useful in CW systems due to the constrained source spectrum, which results in simpler data structures and post-processing and limits its applicability. However, a significant advantage is that an entire CW system can be driven solely by laser diodes, making it much more compact and cost-effective [35-36].

### E. Optical Imaging

A non-invasive method called optical imaging uses light to illuminate the cellular and molecular processes taking place inside the human body. It is thought to be an effective tool for examining deep tissues, where light spreads unevenly [37]. The information is acquired from biomolecular processes and tissue makeup. Either endogenous molecules with optical fingerprints or exogenous agents that provide a signal are used to create contrast. The imaging of tissue anomalies or disease processes is made possible by the diffuse light propagation [38]. Fig. 3

illustrates a commercially used optical imaging system for breast cancer examination, with an example of a captured image shown in Fig. 3.

*F. Optical Imaging Benefits and Risks*

Optical imaging offers a safe and non-ionizing radiation method to visualize tumor characteristics while the patient is comfortably positioned in a prone manner. With its ability to cover a substantial portion of the breast, this technique allows for longitudinal measurements over time. Notably, one of its significant benefits lies in its capacity to differentiate between soft tissues based on their unique absorption or scatter properties, enabling the extraction of functional information through the specific absorption of natural chromophores during the imaging process. However, it's important to take into account that the approach could have a poorer spatial resolution because of the fact that light propagates diffusively through breast tissue. It also shows sensitivity to variables including blood oxygenation, water and blood content, and lipid concentration in breast tissue [39].

*G. Terahertz Spectroscopy*

Considerable efforts have been devoted to the swift advancement of techniques aimed at generating and detecting THz radiation, in order to create THz spectroscopy and imaging equipment. The 'THz gap' must be closed in order to enable more applications, hence it has been crucial to enhance THz systems in terms of power, sensitivity, and the effectiveness of THz sources and detectors. THz continuous wave (CW) imaging and spectroscopy have also attracted a lot of attention. The two main THz imaging and spectroscopy methods are THz time domain spectroscopy (THz TDS) and THz pulse imaging (TPI). Their emission modes, detectors, sources, experimental techniques, and necessary data are different. These methods are thought to have great promise for biological imaging applications because they provide improved picture contrast and selectivity, especially when combined with cutting-edge contrast agents. Electro-optic imaging, near field imaging, single-shot imaging, bi-static THz wave imaging, dark field imaging, THz tomographic imaging with Fractal lenses, and THz computed tomography, also known as THz CT, are among the commonly used techniques for THz imaging. It is beyond the scope of this chapter to provide an exhaustive account of all available THz methods for radiation generation and detection, as well as their applications. Therefore, our focus lies particularly on THz time domain spectroscopy (and THz pulsed imaging) systems, which are employed for imaging and spectroscopy purposes, and their implications in biological research for cancer [38-39].

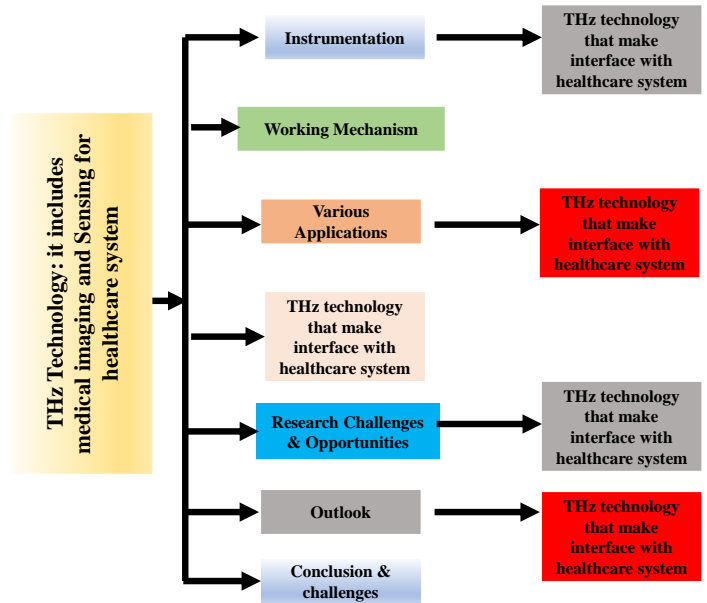

Fig. 4. Application of THz technology for Optical medical imaging system.

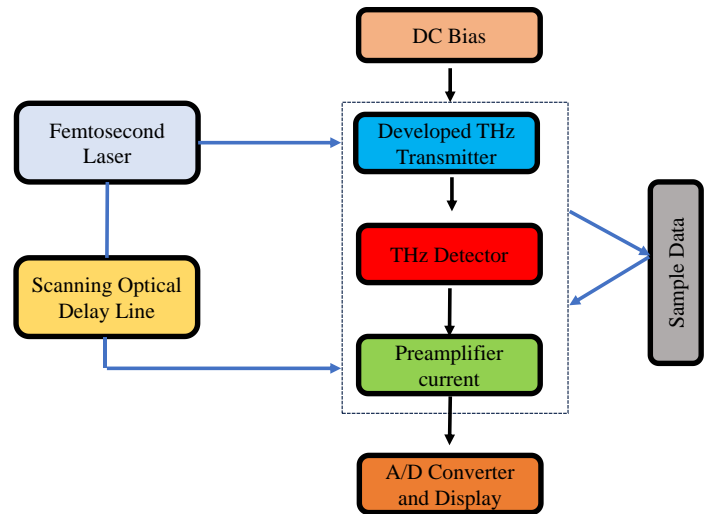

Fig. 5. Major points that are being discuss in this article for the terahertz technology.

Later, additional optics like wave plates, optical choppers, laser amplifiers, gratings, and attenuators may be added. The delay line and the transmitter are separated from the fs laser's output beam. The THz beam is then collimated by a pair of reflectors, and the target item is imaged when it is positioned at the beam's focus. To sample the waveform in the time domain, the optics control the beam delay between the pumping and probing beams delivered to the emitter and detector, respectively. To achieve point-to-point signal collection using the THz-TDS systems, the sample must be moved (laterally translated) while the illumination beam remains fixed. The beam is moved in spectroscopy using stages, piezoelectric rotators, galvo mirrors, and/or other devices.

When employed for the purpose of imaging, a discrete grid is utilized to sample the surface of the object, which is then scanned in either a continuous manner or on a pixel-by-pixel basis in raster mode. Subsequently, the acquired data is subjected to quantization to bits, following retrieval from the data acquisition card (DAQ) [12]. It is noteworthy that THz-TDS systems boast a broad bandwidth, picosecond-level resolution, and field detection that encompasses phase as well as magnitude information for the spectrum [39-40]. These distinctive attributes render them particularly well-suited for a diverse range of applications.

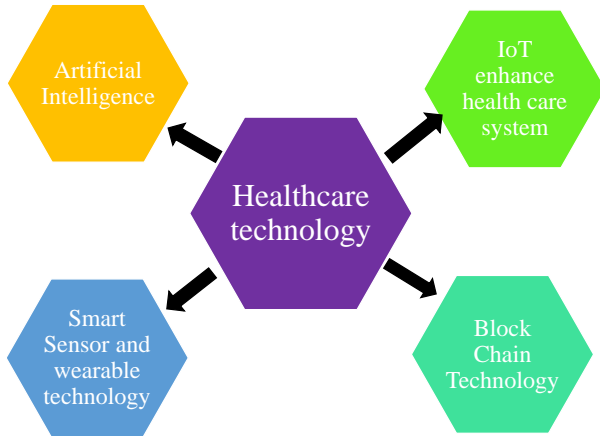

Fig. 6. The block diagram/ the common structure for basic THz TDS.

#### IV. APPLICATION OF THZ OPTICAL TECHNOLOGY APECIFICALLY FOR TREATMENT OF CANCER

##### A. Treatment of cancer

A proposition for a potential method of cancer treatment has been presented, which is based on electromagnetic demethylation of malignant DNA. Malignant DNA demethylation has been proven to significantly contribute to the restoration of gene expression, decrease of tumor growth, and activation of cell death, according to a substantial body of data, as reported in [41], and [42]. Similar outcomes have also been documented when particular demethylation medications like decitabine are used. Furthermore, it has been proposed that resonant high power THz radiation absorption may be used to induce demethylation and boost the effectiveness of cancer treatment.

Recently, there has been a surge in research on noninvasive and label-free THz sensing, utilizing various techniques. Metamaterials and THz plasmonic antennas have enabled the development of high specificity and high sensitivity THz sensors that screen target spectral fingerprints for cell detection, thus eliminating interference signals. The use of THz metamaterials (MM) for quick and affordable THz detection is the main goal of THz sensing. These substances are THz metamaterial

absorbers (TMA), which are periodic structures made intentionally from dielectric and/or sub-wavelength metallic components. TMAs can display special characteristics as anomalous reflection, negative refractive index, sub-diffraction restricted focusing, cloaking, optical magnetism, and the capacity to absorb incident EM radiation thanks to their rich spectral fingerprints in the EM domain. Furthermore, through amplified and strongly confined fields, metamaterials with well-designed structures may sensitively detect minute/thin biological and chemical molecules. TMA has been used in a variety of frequency ranges and sensing applications by altering the absorption spectra parameter. Through the stimulation of localized resonances within metamaterials, TMA THz sensing has been successfully exhibited in a variety of applications. These include the measurement of analyte thickness, detection of biomolecules, design of temperature sensors, detection of environmental refractive index, and design of refractive index-sensitive biosensors with square ring resonator (SRR). Consequently, this methodology presents an alluring approach for attracting novel THz regime applications [43].

The split ring resonators (SRR) and complementary SRR (CSRR) are the most frequently utilized metamaterial structures. The SRR configuration is composed of a metallic pattern in the shape of a ring, which provides inductance, and a narrow opening gap, which delivers high capacitance. It is implemented on the substrate surface. The CSRR, on the other hand, is constructed by etching out a ring-shaped pattern from copper cladded onto the substrate surface to create the dual SRR structure [44]. In this report, we present several TMA designs that have been suggested for the detection of cancerous cells to facilitate point of care diagnosis, given the small detection volume and compact device size. The fundamental idea behind such applications relies on the scattering factors (reflection/transmission coefficients) that are induced by the sensed parameters, such as distinct dielectric changes that result from deviations in the metamaterial resonator's permittivity, refractive index, or permeability that resemble diseased and healthy tissues.

##### B. Thz Technology Interface on Healthcare system

Artificial Intelligence (AI) is a burgeoning domain of computer science that engenders intelligent machines capable of emulating human activities. The healthcare, banking, and transportation industries are witnessing an increase in the proliferation of AI technology. Notably, AI's efficacy, accuracy, and decision-making abilities hold the potential to revolutionize sundry industries. AI assimilates and enhances its capabilities through split learning algorithms, empowering robots to scrutinize colossal datasets and discern patterns and insights that surpass human cognition. This has propelled the development of natural language processing, computer vision, and speech recognition. However, the employment displacement and prejudicial decision-making that AI may engender are concerns that warrant ethical considerations in AI research and development. Ergo, AI's ethical utilization is imperative to improve our society and enrich our lives.

The implementation of ICTs, commonly known as eHealth, has been introduced in the healthcare industry as a result of

technological advancements. The eHealth system is advancing towards (HC4.0 healthcare system by embracing AI, IoT, Big Data, Cloud, and Fog Computing technologies, enabling innovative healthcare-related procedures, such as personalized and remote patient monitoring, virtual multiple care, home care, telemedicine, Electronic Medical and Health Records, and more. The aim of shifting towards intelligent and interconnected healthcare is to provide patients with simplified and tailored treatment. The Healthcare 4.0 Cyber Physical System (HCPS) encompasses a variety of components, including computers, storage, communications, interfaces, bio-actuators, and biosensors. The HCPS paradigm makes use of biosensors to facilitate observations of real-world processes and patient monitoring before, and after the surgery. The HCPS also incorporates bio-actuators, which operate in conjunction with other technologies to monitor patients [41-42].

Fig. 5 and Fig. 6, presents an array of cutting-edge medical imaging technologies that are constituents of the Healthcare 4.0-driven technologies, including AI, IoT (Internet of things) & IoMT, cloud computing, Blockchain, wearable technology, smart sensors, genetic engineering, and 3D printing. These technologies proffer a wide range of benefits that are expected to significantly reduce cancer-related mortalities via early detection, equitable, precise, and personalized care, as well as the integration of pioneering medical imaging technologies like THz imaging for cancer. The advent of THz technology and the digital transformation of the healthcare and biomedical industries introduce another dimension to revolutionize the healthcare sector by adopting AI, IoT, and wireless wearable technologies. Specifically, these technologies encompass cutting-edge medical imaging technologies that utilize AI-enabled machines, such as MRI, CT scan, Terahertz, infrared radiation, and other modalities, smart sensors, and wearable technology for monitoring vital signs, 5G/6G enhanced Telehealth, IoT, and IoMT for connectedness and virtual care, AI and Robotics for clinical decision support systems, data analytics, and precise surgical tools, and Blockchain technology that leverages an open-source distributed database. In this regard, we provide a comprehensive exposition of the advancement of medical imaging technology in the digital age, along with some upcoming THz-based approaches for evaluating and diagnosing patient data at the intersection of healthcare 4.0 technologies, including big data analytics, machine learning, wearables, and the Internet of Things [40-44].

#### *C. The integration of Artificial Intelligence (AI) and Robotics in the field of Healthcare at Terahertz (THz)*

The provision of immediate access in real-time, which allows for the processing of vast quantities of data via reliable transmission lines, represents one means by which healthcare robots are currently enhancing the accessibility of healthcare systems. Recent advancements in wireless wearable technology and home-based robotic instruments have facilitated the remote monitoring of numerous patients and procedures by doctors and surgeons. Moreover, the transition to electronic health records necessitates dependable security measures. The advancement of healthcare systems, encompassing prosthesis replacement, physical therapy, education, and surgical procedures, could derive substantial benefits from the application of these technologies to Terahertz imaging

and sensing [17]. Researchers at the Tokyo Institute of Technology have described a flexible and wearable terahertz scanner prototype [18]. Comprehensive assessments of the utilization of machine learning algorithms in THz imaging and sensing can be found in [18] and [19]. Nevertheless, owing to the insufficient availability of training datasets, the majority of machine learning models explored in THz imaging and sensing for biological applications rely on shallow networks. Convolutional Neural Networks (CNN) are a type of deep learning technique that offers multimodality, resilience, and complexity in systems [20]. Although the use of deep learning in this field has been examined in a few papers, including [21] and [22], our most recent research indicates the development of personalized CNN models and fine-tuned, pretrained CNN models capable of multimodal picture categorization. Recent research has concentrated on THz imaging systems that are integrated with robotics to enhance the versatility of THz systems for in vivo imaging of body geometry and difficult-to-reach areas. Furthermore, the geometries of robotic arms in THz systems make it easier to design portable, adaptable, and small THz systems for ease of use at the point of care.

#### *D. Terahertz technology on Internet Of Things And Wearable Technology*

The utilization of Internet of Things (IoT) technology is a critical concern in the domain of terahertz healthcare. This cutting-edge technology entails a network of tangible objects or devices, commonly referred to as "things," that are interconnected with one another and other devices through the internet. These "things" are equipped with sensors and software, facilitating exchange of data. Examples of IoT components include an implantable chip for heart rate monitoring or any other gadget that can transmit data in small or large bytes across the network. The concept of Internet of Things (IoT) has evolved through the amalgamation of wireless, microelectron mechanical, and internet technologies, with the objective of processing machine-generated and unstructured data for further analysis. To connect web-enabled smart devices with built-in processors to the IoT ecosystem, which collaboratively gathers data from sensors, a cloud-based server/ webservice and IoT gateway are employed [35].

Smart gadgets now have a unique possibility to interact with other cutting-edge devices and share information without the need for human involvement thanks to the Internet of Things (IoT). These gadgets can take human commands, but they can also work on their own. The tracking of daily activities is now significantly aided by wearable technologies. These clever integrated IoT gadgets come with sensors that may be attached to them or to human parts and collect information that can help patients, physicians, and others live better lives. These gadgets currently make it possible to collect medical data in real-time, which enhances both the quality of life and healthcare services. IoT has significantly impacted a number of fields, such as medicine prescription, individualized treatment, and food advice. IoT applications include activity tracking,

Online diagnostics, virtual and real-time monitoring of wellness, and telemedicine employing radio frequency identification and IoT-enabled devices have contributed to improvements in the health sector. Modern hospital systems have been upgraded as a result of technological advancements, including automated appointment scheduling, medical report generating, bill generation, and medication payments. Although novel imaging technologies like THz imaging and IR imaging have been developed, they have not yet been put to use in clinical settings.

The integration of novel imaging modalities with advancements from the fourth industrial revolution, such as artificial intelligence (AI), the internet of things (IoT), big data analytics, virtual reality, and cloud computing, has the potential to transform cancer treatment. This shift involves a transition from numerical data, specifically vital physiological parameters, to the fusion of spatial (image), temporal, and physiological data domains, ultimately leading to personalized healthcare - a key objective of smart healthcare. In a recent study, we proposed a general design for an IoT-enabled CAD system for breast cancer. Our investigation utilized the Thing Speak cloud platform, which features email alert functionality, to conduct IoT simulation and cloud processing. Furthermore, images and training datasets can be transmitted to the cloud for analysis and training purposes, effectively freeing up resources at the acquisition center [45-46].

## V. A NEWLY PROPOSED SPLIT LEARNING BASED METHOD FOR EARLY DETECTION BREAST CANCER USING TERAHERTZ

Using terahertz (THz) imaging on recently removed mouse tumors, this work offers a novel supervised multinomial Bayesian method of learning for the identification of breast cancer. Through the use of two different models—a polynomial regression model and a kernel regression model—the program uses a multinomial Bayesian probit regression technique to build a link between THz data and classification results. By adopting this model-based learning strategy, the algorithm requires only a small set of model parameters, thus reducing the demand for extensive training data in comparison to more complex split learning methods (see in fig. 7).

### A. Comparison to SVM

To confirm the substantial reduction in computational complexity achieved by the proposed algorithm during the training procedure, we conducted a comparative analysis between the results obtained from the proposed classifiers and Support Vector Machines (SVM). To ensure a fair comparison, we deliberately refrained from employing any dimension reduction or reliability-based training selection processes for the SVM classifier. The results, as presented in Table 1 and 2, clearly demonstrate a significant reduction in the training time when using the proposed classifier compared to SVM. Specifically, SVM required 30–36 minutes for training, whereas the probit regression approach accomplished the same task in just one minute in most cases. It's worth noting that the kernel regression applied to Mouse 10B took approximately 37 minutes due to the estimation of a large number of parameters (where  $Q = 442$ ). Therefore, it's evident that the proposed classifier has the potential to drastically decrease training time, especially when the number of parameters is limited, as exemplified by the case where  $Q = 20$ .

The segmentation outcomes produced by the SVM model are subsequently juxtaposed with those of the proposed kernel regression classifier in Fig. 8 and Fig. 9. Specifically, it becomes evident that while the SVM approach exhibits potential in detecting cancer and fat regions, it falls short in completely identifying the muscle region, as depicted in Fig. 9. Furthermore, Fig. 9 provides a concise summary of the quantitative segmentation results obtained from the SVM classifier. Given that an SVM classifier operates as a hard-clustering technique, its performance is depicted as individual points within the ROC curves. These findings further affirm that the proposed classifiers yield superior segmentation results when compared to a widely recognized technique like SVM.

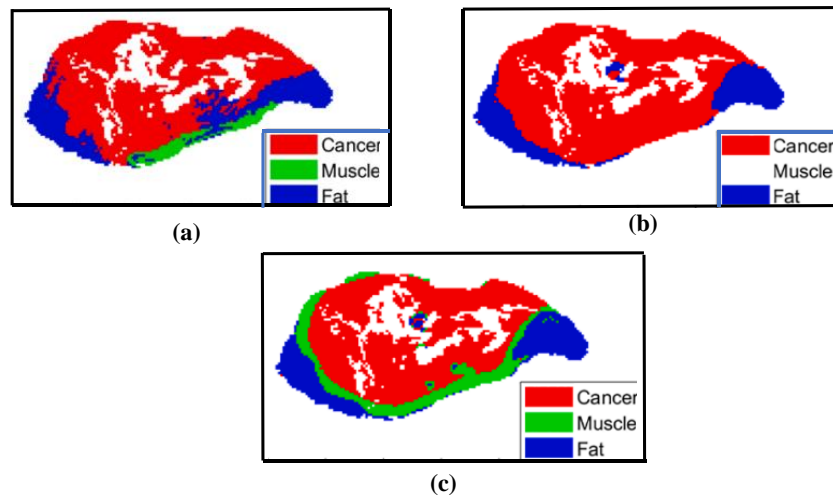

Fig. 7. Sample mouse data having svm model, morphed pathology and the proposed model.

Application of THz Technology	Technology used	Impact and result on given application	References
Covid 19	THz medical imaging, THz spectroscopy, sensing technology	Covid-19 detection, Also the THz technology helps to diagnosis the breathanalysis	[11-12]
Dental Issue	THz spectroscopy, Smart image processing.	Dental diagnosis by the help of characterization of dental tissue	[17-18]
Blood and Plasmaanalysis	THz medical high-definition imaging,THz TDS	It has been work on dielectric properties of blood plasma and find various correlation with available cancerous data	[37-38]
Various cancerousapplication	THz medical high-definition imaging	It work on tumours by the help of various statistical tool.	[42-43]
DNA Analysis	THz spectroscopy	Here, it has been considered the protein molecule that absorption spectra measurement for DNA dynamics.	[44-45]

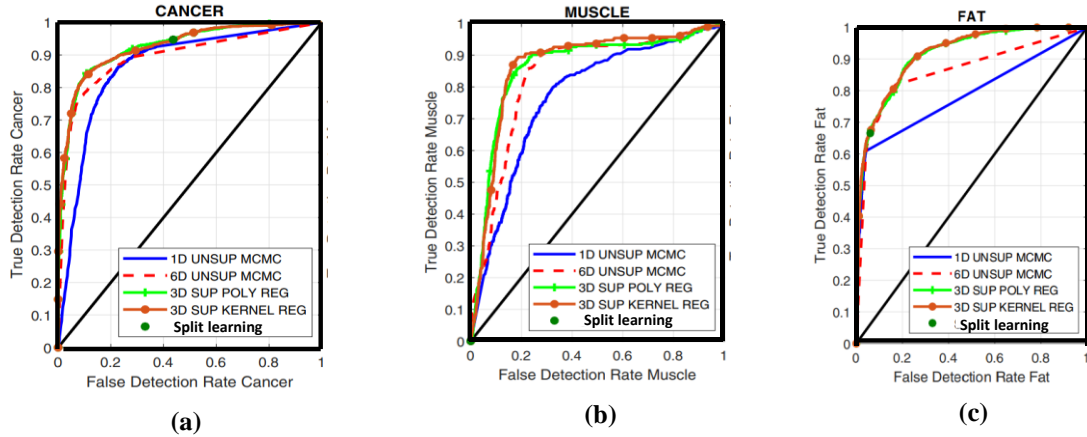

Fig. 8. Comparison of the proposed split learning model with others having different samples.

## VI. CHALLENGES AND FUTURE DIRECTIONS

Despite demonstrating significant potential in biomedical research, THz technology still faces several challenges that must be addressed before it can be widely applied in clinical settings. One major obstacle is the detection sensitivity of THz waves, which does not currently meet the specific requirements for detecting living cells. The constraint in question originates from the physical diffraction threshold and the comparatively greater range of THz wavelength (0.03-3 mm) in relation to the requisite resolution for live cell identification at the micron or even nano-scale. Consequently, overcoming the diffraction and enhancing detection sensitivity remain critical technical bottlenecks that THz technology must overcome in the field of biological detection.

Second, the difficulties in identifying intricate environmental circumstances limit the specificity of THz wave detection. There is high signal interference in biological samples since they usually contain a variety of living cells as well as several macromolecules both within and outside the cells. This interference can lead to the annihilation of the target signal. Consequently, finding effective technical approaches to analyze the spectral characteristics and images derived from detection results is a scientific problem that THz technology must address.

Thirdly, the water sensitivity of THz waves presents a formidable technical challenge in the detection of living cells. Prior research has primarily concentrated on examining molecules, cells, and tissues in solid or dry states, as THz waves are extremely responsive to water. However, this sensitivity becomes a significant roadblock when dealing with water-laden biological samples from humans and water vapor interference in the surrounding environment. Therefore, it is imperative to address and surmount the signal interference and annihilation caused by the water sensitivity in order to detect cells with THz waves.

Not to mention, there is yet no reliable scientific experimental foundation for the biological safety of THz irradiation. Due to its low energy levels, THz wave photon energy was first believed to be secure for cells, tissues, and the human body. Recent research has called into question the bio-safety of THz irradiation in biomedical applications since it has been demonstrated that certain intensities and durations of THz irradiation can cause changes in the genome, proteome, and transcriptome of cells and tissues. Despite these obstacles, a lot of progress has been achieved recently. The use of evanescent waves has enabled non-invasive, in situ, and real-time investigations of cytoplasm leakage and cell hydration state through THz attenuated total reflection spectroscopy. Moreover, the development of various advanced meta-materials has led to the rapid growth of biosensors for qualitative and quantitative detection of bacteria and cell hydration state analysis, potentially enhancing routine clinical detections. Furthermore, exciting advances have been achieved by combining THz technology with conventional endoscopic systems, offering real-time and visual imaging



during non-destructive detection and surgical procedures. As a result, THz technology has witnessed unprecedented progress and is steadily advancing towards clinical applications.

## VII. CONCLUSION

Significant strides and substantial potential for application have been achieved within the realm of THz biomedical and biomolecular detection, as well as tissue imaging, with notable advancements in clinical contexts. Nevertheless, the broader utilization of this technology in medical sciences faces several challenges that necessitate resolution. The current high cost of THz systems acts as a hindrance to their integration into routine healthcare practices. Addressing this concern alongside enhancing accuracy, real-time acquisition speed, reproducibility of analytical data, signal-to-noise ratios, and the development of portable, cost-effective, and safe solid-state systems augmented with AI and IoT capabilities is vital to enable expansive clinical applications of THz technology. In addition, we have introduced a hybrid supervised multinomial with Bayesian learning approach, which helps to find cancer using THz imaging of available data samples. This algorithm (see fig. 7) produces multinomial Bayesian ordinal probit regression models to conduct classifications within the THz images. To determine the connection between terahertz features and their corresponding classification outcomes, the method employs two different regression models: one is polynomial regression model and the other one is kernel regression model. Notably, this supervised learning strategy demands a substantially reduced volume of training data compared to alternative supervised approaches like Convolutional Neural Networks (CNN). During the training phase, a consideration is given to the deformation of body tissue during its histopathology process to account for mismatches between THz images and pathology results.

## REFERENCE

- [1] P. Martyniuk, J. Antoszewski, M. Martyniuk, L. Faraone, and A. "Rogalski", "New concepts in infrared photodetector designs," *Applied Physics Reviews*, vol. 1, pp. 41–102, 2014.
- [2] M. Nagel, P. H. Bolivar, M. Brucherseifer, H. Kurz, A. Bosserhoff, and R. Buttner, "Integrated THz technology for label-free genetic diagnostics," *Applied Physics Letters*, vol. 80, no. 1, pp. 154–154, 2002.
- [3] H. R. Chi, M. D. F. Domingues, H. Zhu, C. Li, K. Kojima, and A. Radwan, "Healthcare 5.0: In the Perspective of Consumer Internet-of-Things-Based Fog/Cloud Computing," *IEEE Transactions on Consumer Electronics*, 2023.
- [4] N. Karpowicz, H. Zhong, C. Zhang, K. I. Lin, J. S. Hwang, J. Xu, and X. C. Zhang, "Compact continuous-wave subterahertz system for inspection applications," *Applied Physics Letters*, vol. 86, no. 5, pp. 54–105, 2005.
- [5] K. Yamamoto, M. Yamaguchi, F. Miyamaru, M. Tani, and M. Hangyo, "Non-invasive inspection of c-4 explosive in mails by terahertz time-domain spectroscopy," *Journal of Applied Physics*, vol. 43, no. 3B, pp. 414–414, 2004.
- [6] T. Darwish, S. Korouri, M. Pasini, M. Veronica, C. William, and Ishak, "Integration of Advanced Health Technology Within the Healthcare System to Fight the Global Pandemic: Current Challenges and Future Opportunities," *Innovations in clinical neuroscience*, 2021.
- [7] S. K. Mathanker, P. R. Weckler, and N. Wang, "Terahertz (THz) applications in food and agriculture: A review," *Transactions of the ASABE*, vol. 56, no. 3, pp. 1213–1226, 2013.
- [8] X. Chen, H. Lindley-Hatcher, R. I. Stantchev, J. Wang, K. Li,

- A. H. Serrano, . . Pickwell-Macpherson, and E, "Terahertz (THz) biophotonics technology: Instrumentation, techniques, and biomedical applications," *Chemical Physics Reviews*, vol. 3, no. 1, 2022.
- [9] G. Srivastava and S. Agarwal, "Terahertz imaging: timeline and future prospects," in *Terahertz Devices, Circuits and Systems: Materials, Methods and Applications*. Springer Nature, 2022, pp. 267–287.
- [10] Swati, Sikdar., Sayanti, Guha. (2020). *Advancements of Healthcare Technologies: Paradigm Towards Smart Healthcare Systems*. doi: 10.1007/978-981-15-2740-1\_9
- [11] W. Kim., J. Kim. (2019). *Innovative technologies for the smart E-Healthcare system. Investigative and Clinical Urology*.
- [12] G. Maarten, P. Poirot., Praneeth Vepakomma., C. Ken, J. Kalpathy-Cramer., R. Gupta., R. Raskar. (2019). *Split Learning for collaborative deep learning in healthcare*. arXiv: Learning.
- [13] D. Zhuang, N.Nguyen, K. Chen, & J. M. Chang, J. M. (2020). *Saia: Split artificial intelligence architecture for mobile healthcare system*. arXiv preprint arXiv:2004.12059.
- [14] I., M., Chekrygina., A., E., Chekrygin., V., E., Chekrygin. (2010). *Technology terahertz — Medicine*.
- [15] A. Banerjee, S. Vajandar, and T. Basu, "Prospects in medical applications of terahertz waves," in *Terahertz Biomedical and Healthcare Technologies: Materials to Devices*, A. Banerjee, B. Chakraborty, H. Inokawa, and J. Roy, Eds. The Netherlands: Academic, 2020, pp. 225–239.
- [16] M. Danciu, T. Alexa-Stratulat, C. Stefanescu, G. Dodi, I. Tamba, C. T. Mihai, and G. D. Stanciu, "Terahertz spectroscopy and imaging: A cutting-edge method for diagnosing digestive cancers," *Materials*, vol. 12, no. 9, pp. 1–16, 2019.
- [17] F. Zhang, K. Tominaga, M. Hayashi, and M. Tani, "A quantitative interpretation for the difference of terahertz spectra of DL- and L-alanine: Origins of infrared intensities in terahertz spectroscopy," *J. Phys. Chem. C*, vol. 125, no. 29, pp. 16175–16182, 2021.
- [18] A. V. Badin, A. I. Berdyugin, V. D. Moskalenko, T. N. Shematilo, K. V. Simonova, and D. D. Teterina, "Continuous Wave THz Imaging System for Defectoscopy of Polymeric Ferroelectric Materials," *2022 IEEE 23rd International Conference of Young Professionals in Electron Devices and Materials (EDM)*, pp. 618–623, 2022
- [19] J. Hu, H. Zhang, S. Sfarra, E. Pivarciová, Y. Yao Y. Duan, . . Maldague, and X, "Autonomous dynamic line-scan continuous-wave terahertz non-destructive inspection system combined with unsupervised exposure fusion," *NDT & E International*, vol. 132, pp. 102 705–102 705, 2022.
- [20] M. Pan, Y. Fu, M. Zheng, H. Chen, Y. Zang, H. Duan, . . Hu, and Y, "Dielectric metalens for miniaturized imaging systems: progress and challenges," *Light: Science & Applications*, vol. 11, no. 1, pp. 195–195, 2022.
- [21] S. Gao, K. Yang, H. Shi, K. Wang, and J. Bai, "Review on panoramic imaging and its applications in scene understanding," *IEEE Transactions on Instrumentation and Measurement*, vol. 71, pp. 1–34, 2022.
- [22] J. Wu, Y. Guo, C. Deng, A. Zhang, H. Qiao, Z. Lu, Dai, and Q, "An integrated imaging sensor for aberration-corrected 3D photography," *Nature*, no. 7938, pp. 62–71, 2022
- [23] E. Castro-Camus, M. Koch, and D. M. Mittleman, "Recent advances in terahertz imaging: 1999 to 2021," *Applied Physics B*, vol. 128, no. 1, pp12–12, 2022.
- [24] G. Lee, J. Lee, Q. H. Park, and M. Seo, "Frontiers in terahertz imaging applications beyond absorption cross-section and diffraction limits," *ACS Photonics*, vol. 9, no. 5, pp. 1500–1512, 2022.
- [25] X. Sun, S. Chen, C. Kuang, W. Fu, X. Li, Z. Duan, and Q. Wen, "Gradient-Reduced Graphene Oxide Aerogel with Ultrabroadband Absorption from Microwave to Terahertz Bands," *ACS Applied Nano Materials*, vol. 6, no. 5, pp. 3893–3902, 2023.
- [26] N. A. Mohammed, O. E. Khedr, E. S. M. El-Rabaie, and A. A. Khalaf, "High-Sensitivity Early Detection Biomedical Sensor for Tuberculosis With Low Losses in the Terahertz Regime Based on Photonic Crystal Fiber Technology," *Photonic Sensors*, vol. 13, no. 2, pp. 230 202–230 202, 2023.
- [27] A. A. Gavdush, O. P. Cherkasova, . . Tuchin, and V. V, "The progress and perspectives of terahertz technology for diagnosis of neoplasms: a review," *Journal of Optics*, vol. 22, no. 1, pp. 13 001–13 001, 2019.
- [28] N. Vohra, H. Liu, A. H. Nelson, K. Bailey, and M. El-Shenawee, "Hyperspectral terahertz imaging and optical clearance for cancer classification in breast tumor surgical specimen," *Journal of Medical Imaging*, vol. 9, no. 1, pp. 14 002–014 002, 2022.
- [29] Yan, Z., Zhu, L. G., Meng, K., Huang, W., & Shi, Q. (2022). THz medical imaging: from in vitro to in vivo. *Trends in Biotechnology*, 40(7), 816-830.
- [30] Castro-Camus, E., Koch, M., & Mittleman, D. M. (2022). Recent advances in terahertz imaging: 1999 to 2021. *Applied Physics B*, 128(1), 12.
- [31] Gezimati, M., & Singh, G. (2023). Curved synthetic aperture radar for near-field terahertz imaging. *IEEE Photonics Journal*.
- [32] Hu, J., Zhang, H., Sfarra, S., Pivarciová, E., Yao, Y., Duan, Y., ... &

- Maldague, X. (2022). Autonomous dynamic line-scan continuous-wave terahertz non-destructive inspection system combined with unsupervised exposure fusion. *NDT & E International*, 132, 102705.
- [33] Badin, A. V., Berdyugin, A. I., Moskalenko, V. D., She-matilo, T. N., Simonova, K. V., & Teterina, D. D. (2022, June). Continuous Wave THz Imaging System for Defectoscopy of Polymeric Ferroelectric Materials. In 2022 IEEE 23rd International Conference of Young Professionals in Electron Devices and Materials (EDM) (pp. 618-623).
- [34] Di Fabrizio, M., D'Arco, A., Mou, S., Palumbo, L., Petrarca, M., & Lupi, S. (2021). Performance evaluation of a THz pulsed imaging system: Point spread function, broadband THz beam visualization and image reconstruction. *Applied Sciences*, 11(2), 562.
- [35] Woodward, R. M., Cole, B. E., Wallace, V. P., Pye, R. J., Arnone, D. D., Linfield, E. H., & Pepper, M. (2002). Terahertz pulse imaging in reflection geometry of human skin cancer and skin tissue. *Physics in Medicine & Biology*, 47(21), 3853.
- [36] Berry, E., Walker, G. C., Fitzgerald, A. J., Zinov'Ev, N. N., Chamberlain, M., Smye, S. W., ... & Smith, M. A. (2003). Do in vivo terahertz imaging systems comply with safety guidelines?. *Journal of Laser Applications*, 15(3), 192-198.
- [37] Kakimi, R., Fujita, M., Nagai, M., Ashida, M., & Nagatsuma, T. (2014). Capture of a terahertz wave in a photonic-crystal slab. *Nature Photonics*, 8(8), 657-663.
- [38] Huang, Y., Shen, Y., & Wang, J. (2022). From terahertz imaging to terahertz wireless communications. *Engineering*.
- [39] Yan, H., Huo, H., Xu, Y., & Gidlund, M. (2010). Wireless sensor network based E-health system-implementation and experimental results. *IEEE Transactions on Consumer Electronics*, 56(4), 2288-2295.
- [40] Sundaravadivel, P., Kougianos, E., Mohanty, S. P., & Ganapathiraju, M. K. (2017). Everything you wanted to know about smart health care: Evaluating the different technologies and components of the internet of things for better health. *IEEE Consumer Electronics Magazine*, 7(1), 18-28.
- [41] Han, D. M., & Lim, J. H. (2010). Design and implementation of smart home energy management systems based on zigbee. *IEEE Transactions on Consumer Electronics*, 56(3), 1417-1425.
- [42] Ray, P. P., Dash, D., Salah, K., & Kumar, N. (2020). Blockchain for IoT-based healthcare: background, consensus, platforms, and use cases. *IEEE Systems Journal*, 15(1), 85-94.
- [43] Jabbar, H., Song, Y. S., & Jeong, T. T. (2010). RF energy harvesting system and circuits for charging of mobile devices. *IEEE Transactions on Consumer Electronics*, 56(1), 247-253.
- [44] Pistore, V., Pogna, E. A., Viti, L., Li, L., Davies, G., Linfield, E. H., & Vitiello, M. S. (2023, March). Terahertz detectorless hyperspectral near-field imaging and spectroscopy exploiting QCL frequency combs. In *Quantum Sensing and Nano Electronics and Photonics XIX* (p. PC124300C). SPIE.
- [45] Gezimati, M., & Singh, G. (2023). Terahertz imaging and sensing for healthcare: current status and future perspectives. *IEEE Access*.
- [46] Gezimati, M., & Singh, G. (2023). Advances in terahertz technology for cancer detection applications. *Optical and Quantum Electronics*, 55(2), 151.